

# Rack ATS with Network Management Card 3

## User Guide



AP44XXA

990-91718C-001  
Release date: September 2025

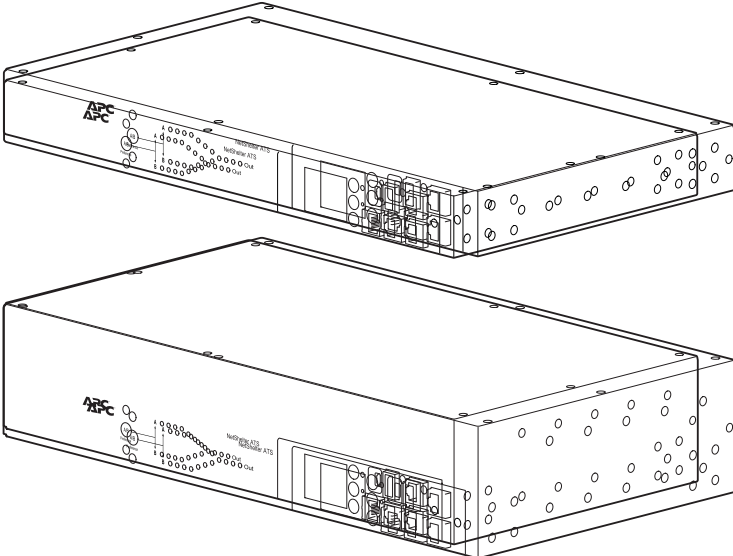

# Legal Information

The information provided in this document contains general descriptions, technical characteristics and/or recommendations related to products/solutions.

This document is not intended as a substitute for a detailed study or operational and site-specific development or schematic plan. It is not to be used for determining suitability or reliability of the products/solutions for specific user applications. It is the duty of any such user to perform or have any professional expert of its choice (integrator, specifier or the like) perform the appropriate and comprehensive risk analysis, evaluation and testing of the products/solutions with respect to the relevant specific application or use thereof.

The Schneider Electric brand and any trademarks of Schneider Electric SE and its subsidiaries referred to in this document are the property of Schneider Electric SE or its subsidiaries. All other brands may be trademarks of their respective owner.

This document and its content are protected under applicable copyright laws and provided for informative use only. No part of this document may be reproduced or transmitted in any form or by any means (electronic, mechanical, photocopying, recording, or otherwise), for any purpose, without the prior written permission of Schneider Electric.

Schneider Electric does not grant any right or license for commercial use of the document or its content, except for a non-exclusive and personal license to consult it on an "as is" basis.

Schneider Electric reserves the right to make changes or updates with respect to or in the content of this document or the format thereof, at any time without notice.

**To the extent permitted by applicable law, no responsibility or liability is assumed by Schneider Electric and its subsidiaries for any errors or omissions in the informational content of this document, as well as any non-intended use or misuse of the content thereof.**

APC, the APC logo, Data Center Expert, EcoStruxure IT, NetShelter, and Powernet are the property of Schneider Electric SE or its subsidiaries. All other brands may be trademarks of their respective owners.

---

# Table of Contents

Important Safety Instructions — SAVE THESE INSTRUCTIONS .....	9
Safety Instruction .....	10
Overview .....	11
Additional Documentation .....	11
User Comments .....	11
Product Features .....	12
Internal Protection Measures .....	13
How Switching Works .....	14
Types of User Accounts .....	15
Watchdog Features .....	16
Network Interface Watchdog Mechanism .....	16
Resetting the Network Timer .....	16
Network Port Sharing (NPS) .....	17
Display ID .....	17
Install an NPS Group .....	17
Specific Assignment of Display IDs .....	18
Firmware Upgrade with NPS .....	18
Getting Started .....	19
Establish Network Settings .....	19
About IPv4 Setup .....	19
About IPv6 Setup .....	20
TCP/IP Configuration Methods .....	20
.ini File Utility .....	24
Updating Firmware .....	25
Firmware File Transfer Methods .....	25
Use the Firmware Update Utility .....	26
Use FTP or SCP to Update One Rack ATS .....	27
Use XMODEM to Upgrade One Rack ATS .....	28
Use a USB Drive To Transfer and Update Files .....	28
How To Update Multiple Rack ATS Units .....	29
Firmware Upgrade with NPS .....	29
Verifying Upgrades and Updates .....	30
Verify the Success Or Failure of the Transfer .....	30
Last Transfer Result Codes .....	30
Verify the Version of Installed Firmware .....	30
Network Management with Other Applications .....	31
Recover from a Lost Password .....	32
Front Panel Overview .....	33
Device Status LED .....	34
Network Status LED .....	34
10/100/1000 Status LED .....	34
LCD Display Screens .....	35
Default Screens .....	36

Menu screens .....	37
Alarm Status Indicators .....	39
Command Line Interface .....	40
Log On to the CLI .....	40
Local Access to the CLI .....	40
Remote Access to the CLI .....	41
About the Main Screen .....	42
Using the CLI .....	44
Command Syntax .....	45
Command Response Codes .....	46
Prompting for User Input during Command Execution .....	46
Command Editing .....	46
History .....	46
Auto Completion .....	47
Delimiter .....	47
Options and Arguments Inputs .....	47
Response Format and Message Codes .....	48
Network Management Card Command Descriptions .....	49
? .....	49
about .....	51
alarmcount .....	51
boot .....	52
bye .....	53
cd .....	53
clrrst .....	53
console .....	54
date .....	55
delete .....	55
dir .....	56
dns .....	57
eapol .....	58
email .....	59
eventlog .....	61
exit .....	62
firewall .....	62
format .....	62
ftp .....	64
help .....	64
lang .....	64
lastrst .....	65
ldap .....	65
ledblink .....	69
logzip .....	69
netstat .....	70
ntp .....	70
ping .....	71
portSpeed .....	71

prompt.....	72
pwd .....	72
quit.....	72
radius .....	73
reboot.....	74
resetToDef .....	74
session.....	75
smtp .....	76
snmp .....	77
snmpv3.....	78
snmptrap .....	78
ssh .....	79
ssl .....	79
system.....	81
tacacs+.....	83
tcpip .....	83
tcpip6 .....	84
user.....	85
userauth .....	86
userdfit .....	86
web .....	87
whoami.....	88
wifi .....	88
xferINI .....	89
xferStatus .....	89
Device Command Descriptions .....	90
Network Port Sharing Commands.....	90
aboutATS.....	90
atsMeasure.....	91
atsStatus .....	91
bkLowLoad .....	92
bkNearOver .....	93
bkOverLoad .....	94
bkPeakLoad.....	95
bkReading .....	96
dispID.....	97
eventCounts .....	97
freqDeviat.....	98
frontPanel.....	99
Humidity Sensor Note:.....	100
humAIGen .....	100
humHyst.....	101
humLow.....	102
humMin .....	103
humReading .....	104
humStatus .....	104
lcd .....	105
lcdBlink.....	105

lineVRMS .....	106
logToFlash .....	107
modbus .....	108
phLowLoad .....	109
phNearOver .....	109
phOverLoad .....	110
phPeakLoad .....	110
phReading .....	111
prodInfo .....	111
sensorName .....	112
sourceAName .....	112
sourceBName .....	113
sourcePref .....	113
Temperature Sensor Note: .....	114
tempAlGen.....	114
tempHigh .....	115
tempHyst .....	116
tempMax .....	117
tempPeak .....	118
tempReading .....	118
vMediumLimit.....	119
vNarrowLmt .....	120
vSensitvty .....	121
vWideLmt .....	122
vXferRange.....	123
<b>Web User Interface .....</b>	<b>124</b>
Log on to the Web UI.....	124
URL address formats.....	125
First Log On .....	125
Web UI Features .....	126
Tabs .....	126
Limited Status Access.....	126
Device Status Icons .....	127
Quick Links .....	127
Network Port Sharing (NPS) on the Web UI.....	128
<b>Home Tab .....</b>	<b>129</b>
<b>Status Tab.....</b>	<b>130</b>
View NPS Groups .....	130
View Device Alarms .....	131
View Device Status .....	131
View The Unit Status .....	132
View Load Status .....	132
View Power Measurements.....	133
View Environment Status .....	133
View Network Status .....	134
<b>Control Tab .....</b>	<b>136</b>
Manage User Sessions.....	136

Web CLI .....	136
Reset the Network Interface .....	137
<b>Configuration Tab .....</b>	<b>138</b>
Configure the Rack ATS .....	139
Configure NPS Groups .....	139
Configure Rack ATS Name and Location .....	140
Set Preferred Power Source .....	140
Configure Switching Behavior .....	141
Configure Load Thresholds .....	144
Turn the LCD Display On or Off .....	145
Configure Temperature and Humidity Sensors .....	145
Manage Security Settings .....	147
Manage Settings for User Sessions .....	147
Enable Ping Response .....	148
Manage Local User Settings .....	148
Configure Default User Settings .....	150
Manage Remote User Settings .....	151
Configure a RADIUS Server .....	152
Firewall Menus .....	153
802.1X Security Configuration .....	155
Configure Network Settings .....	156
Protocol Configuration Summary .....	156
Configure TCP/IP and Communication Settings for IPv4 and IPv6 .....	157
Configure Network Port Speed .....	158
Configure DNS .....	159
Test DNS Configuration .....	159
Configure Web Access .....	160
Configure SSL Certificate for Web Access .....	161
Configure CLI Access .....	161
Configure SSH Host Key .....	162
SNMP Options .....	163
SNMPv1 .....	164
SNMPv3 .....	165
Enable Modbus TCP .....	167
Configure FTP Server .....	167
Wi-Fi Configuration with AP9834 .....	169
Configure Notifications .....	169
Configure Notifications By Event .....	169
Configure Notifications By Group .....	170
Set Up E-mail Notifications .....	171
SNMP Traps .....	173
General Configuration .....	174
Configure identification .....	174
Configure Date, Time, and Daylight Savings .....	175
Create and Import Settings with the Config File .....	176
Configure Quick Links .....	176
Configure Logs .....	177

---

Identify Syslog Servers .....	177
Configure Syslog Settings .....	177
Test Syslog Servers .....	178
<b>Tests Tab</b> .....	179
Set the LCD Light to Blink .....	179
Set the LED Light to Blink .....	179
<b>Logs Tab</b> .....	180
View and Configure the Event Log .....	180
Viewing the Event Log .....	180
Reverse Lookup .....	181
Change the Log Size .....	182
Network Port Sharing Event Logs and Traps .....	182
View and Configure the Data Log .....	182
Log .....	182
Graphing .....	183
Set Logging Intervals .....	183
Configure Rotation Settings .....	184
Specify Data Log Size .....	184
Firewall Log .....	185
Use FTP or SCP to Retrieve Log Files .....	185
Download Log Files to a USB Flash Drive .....	186
<b>About Tab</b> .....	187
About the Rack ATS .....	187
About the Network .....	187
Support Resources .....	188
<b>How to Export Configuration Settings</b> .....	189
Summary of the Procedure .....	189
Contents of the .ini File .....	189
.ini and Network Port Sharing .....	189
Detailed Procedures .....	190
Retrieve .ini File .....	190
Edit .ini File .....	191
Transfer the File To a Single Rack ATS .....	191
Transfer the File To Multiple Rack ATS Units .....	191
The Upload Event and Error Messages .....	192
The Event and Its Error Messages .....	192
Messages in Config.ini .....	192
Errors Generated By Overridden Values .....	192
Related Topics .....	192
<b>Troubleshooting</b> .....	193
Access Problems .....	193
SNMP Problems .....	194
<b>Worldwide Customer Support</b> .....	195
<b>Source Code Copyright Notice</b> .....	196

# Important Safety Instructions — SAVE THESE INSTRUCTIONS

Read these instructions carefully and look at the equipment to become familiar with it before trying to install, operate, service or maintain it. The following safety messages may appear throughout this manual or on the equipment to warn of potential hazards or to call attention to information that clarifies or simplifies a procedure.



The addition of this symbol to a “Danger” or “Warning” safety message indicates that an electrical hazard exists which will result in personal injury if the instructions are not followed.



This is the safety alert symbol. It is used to alert the user to potential personal injury hazards. Obey all safety messages with this symbol to avoid possible injury or death.

## **⚠ DANGER**

**DANGER** indicates a hazardous situation which, if not avoided, **will result in death or serious injury.**

**Failure to follow these instructions will result in death or serious injury.**

## **⚠ WARNING**

**WARNING** indicates a hazardous situation which, if not avoided, **could result in death or serious injury.**

**Failure to follow these instructions can result in death, serious injury, or equipment damage.**

## **⚠ CAUTION**

**CAUTION** indicates a hazardous situation which, if not avoided, **could result in minor or moderate injury.**

**Failure to follow these instructions can result in injury or equipment damage.**

## **NOTICE**

**NOTICE** is used to address practices not related to physical injury. The safety alert symbol shall not be used with this type of safety message.

**Failure to follow these instructions can result in equipment damage.**

## Please Note

Electrical equipment should only be installed, operated, serviced, and maintained by qualified personnel. No responsibility is assumed by Schneider Electric for any consequences arising out of the use of this material.

A qualified person is one who has skills and knowledge related to the construction, installation, and operation of electrical equipment and has received safety training to recognize and avoid the hazards involved.

Always abide strictly by local laws and regulations in force in the place of installation.

## Safety Instruction

### **DANGER**

#### **HAZARDOUS VOLTAGE**

Do not operate the Rack ATS outside Rated Voltage (+/- 10%). Voltage limits and transfer ranges represent software control of switching behavior, not input voltages for use.

**Failure to follow these instructions will result in death or serious injury.**

# Overview

The APC™ Rack Automatic Transfer Switch (Rack ATS) with Network Management Card 3 (NMC3) provides redundant power to single-corded equipment loads, such as servers. The Rack ATS has two input power cords that supply power to the connected loads from both a primary and secondary power source. If the primary source becomes unavailable or goes out of the configured power range, the Rack ATS will switch to draw power from the secondary source without interrupting critical loads. The Rack ATS has built-in network connectivity, which allows remote management via the Web User Interface (Web UI), its Command Line Interface (CLI), Data Center Expert™, EcoStruxure™ IT, or Simple Network Management Protocol (SNMP).

**NOTE:** The Schneider Electric Network Management Card (NMC) enables essential and secure remote monitoring and management of your Rack PDU.

**NOTE:** Update your firmware to the latest version after startup. Check [www.se.com](http://www.se.com) for the latest version of the Rack ATS firmware. Enter the model number for your equipment in the Search bar of the website's home page ([www.se.com](http://www.se.com)). Select the desired product from the search results to open that product page. Select the Software & Firmware tab on the product page to view and download any available firmware for that product.

## Additional Documentation

You can find the latest version of this manual and additional documentation on [www.se.com](http://www.se.com).

- *Safety Sheet:* Includes critical safety information for the Rack ATS.
- *Installation Manual:* Describes the procedure for physical installation and initial setup of your Rack ATS
- *Release Notes:* Describes new features, fixed issues, and known issues for the latest firmware version.
- *Security Handbook:* Describes security features for the Network Management Card and for devices with embedded components of the Network Management Card.

To find product documentation online,

1. Go to the Schneider Electric download center at [www.se.com/ww/en/download](http://www.se.com/ww/en/download).
2. Click **Select location** and select your location from the list.

**NOTE:** You cannot download documentation until you have selected a location.

3. In the Search bar, enter the title of your document, the part number of your document, or the part number of your equipment. Press enter or click the magnifying glass icon to start the search.
4. Download the desired document from the search results. If needed, you can select the filters at the left of the web page to narrow the search results.

Alternatively, you can find all the documentation for a single product at [www.go2se.com/ref=product part number](http://www.go2se.com/ref=product%20part%20number) > **Documentation** > **Product Documentation**.

## User Comments

We welcome your comments about this document. Contact us at [www.se.com](http://www.se.com).

## Product Features

The Rack ATS has these additional features:

- LED indicators on the front panel of the unit indicate operation conditions such as preferred source, overload current, and Web connectivity. These conditions can also be monitored via the CLI and Web UI.
  - Gigabit Ethernet connectivity.
  - Various levels of access: Super User, Administrator, Device User, Read-Only, and Network-Only User. (These have user name and password requirements.)
  - A multiple-user login feature, which allows up to four users to be logged in simultaneously.
  - Event and data logging. The Event Log is accessible by Telnet, Secure CoPy (SCP), File Transfer Protocol (FTP), serial connection, or Web browser (using HTTPS access with SSL/TLS, or using HTTP access). The Data Log is accessible by Web browser, SCP, or FTP.
  - SNMP traps, Syslog messages, and e-mail notifications based on the severity level or category of Rack ATS and NMC system events.
  - Security protocols for authentication and encryption.
  - The ability to monitor sources and set source-transfer parameters via Web and CLI interfaces.
  - Supports Modbus TCP that enables the building management system to monitor the Automatic Transfer Switch (ATS).
  - Set alarm thresholds that provide network and visual alarms to help you prevent overloaded circuits.
  - Temperature and Humidity monitoring (with APC Temperature/Humidity sensors AP9335T and AP9335TH, not included).
  - Internal protection measures against short circuits. (See [Internal Protection Measures](#), page 13 for details.)
- NOTE:** It is recommended that you always connect each Rack ATS source to a Double Conversion On-Line Uninterruptible Power Supply (UPS).
- Network Port Sharing (NPS): Up to 32 AP44XXA Series Rack ATS Units can be connected using the Link A and B ports so that only one network connection is necessary.
  - An NPS guest firmware auto-update feature allows the NPS host to automatically pass a firmware update to its connected guests.

### **NOTICE**

Update the firmware to enable NPS features.

See [Firmware File Transfer Methods](#), page 25 for instructions to update the firmware.

# Internal Protection Measures

Rack ATS units may include the following internal protection measures:

Input relays in every model open when their source is disconnected to help prevent electric backfeed from one input cord into another (ATS 1).

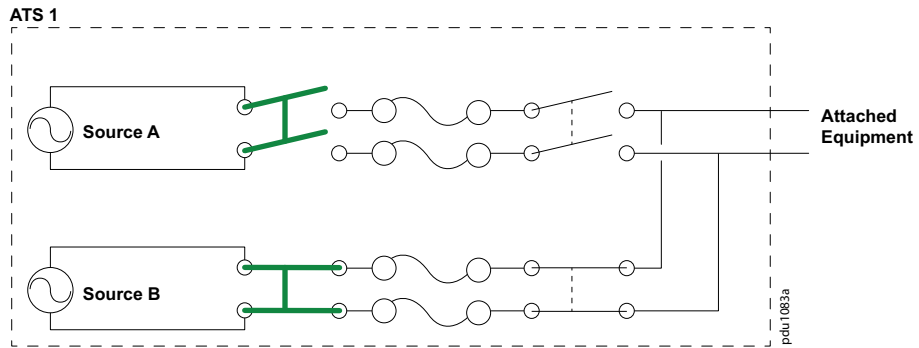

Two or four non-replaceable fuses (depending on the model) help to protect the Rack ATS from short circuits (ATS 2).

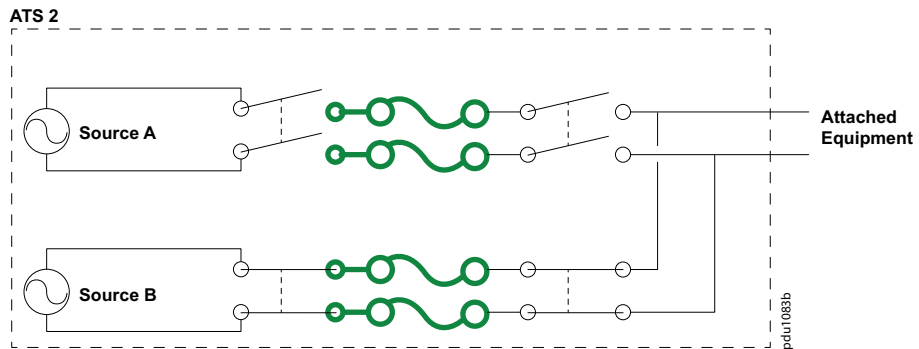

Some 2U models have two single- or double-pole circuit breakers to help protect against bank overloads (ATS 3).

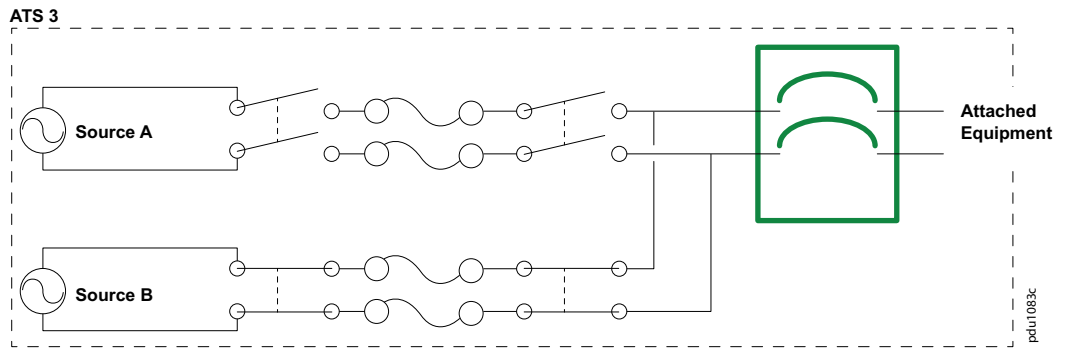

The Rack ATS does not include power surge protection. To help protect your Rack ATS from external power surges, it is recommended that you always connect each Rack ATS source to a Double Conversion On-Line Uninterruptible Power Supply (UPS).

## How Switching Works

Switching behavior is determined by several performance parameters: Line VRMS, Transfer Limits, Transfer Ranges, and Sensitivity. You can adjust these parameters so that the Rack ATS accepts power that meets the needs of your equipment (see Configuration Tab, page 138 for more details).

- **Line VRMS:** The ideal voltage range for your equipment. Acceptable line voltages vary per Rack ATS model (see the *Specification Sheet* for your Rack ATS model on [www.se.com](http://www.se.com)).
- **Transfer limits:** The maximum and minimum voltages the Rack ATS will accept before switching sources. Transfer limits are meant to allow for small, acceptable surges and drops in power. Do not allow the Rack ATS to operate near the high transfer limit for long periods of time, as this can reduce the life expectancy of the Rack ATS and your equipment.
- **Transfer ranges:** Pre-defined sets of transfer limits. You can configure up to three transfer ranges, but you can enable only one transfer range at a time.
- **Sensitivity:** How long the Rack ATS waits to determine whether or not it will switch sources. High sensitivity provides extra responsiveness for delicate equipment. Low sensitivity helps to prevent excessive switching in cases of fluctuating power inputs.

**NOTE:** The entire switching process takes a maximum of 10 milliseconds (ms) at high sensitivity, and 12 ms at low sensitivity. (This applies to both 50 Hz and 60 Hz sources.)

The Rack ATS constantly monitors the voltage and frequency of power coming from sources A and B. If one source begins to supply power that does not fall within the performance parameters, the Rack ATS will disqualify that source. One of two things happens next:

1. If the disqualified source *is not* in use, the Rack ATS will generate an alarm to indicate that redundancy has been lost.
2. If the disqualified source *is* in use, the Rack ATS will switch to draw power from the other available source.

If a preferred source is set, the Rack ATS will wait 30 seconds to monitor that source. After 30 seconds, if the preferred source becomes usable again, the Rack ATS will switch back to the preferred source.

### Example:

Source A is providing power to the attached equipment, while Source B is isolated from the attached equipment.

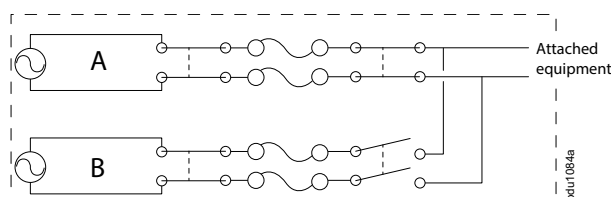

Firmware detects that Source A is out of the user-specified transfer range. The input power from Source A is removed by disengaging the relay. This allows for out-of-phase switching and significantly reduces the opportunity for relay welding. (The first relay will only open if the input voltage is too low.)

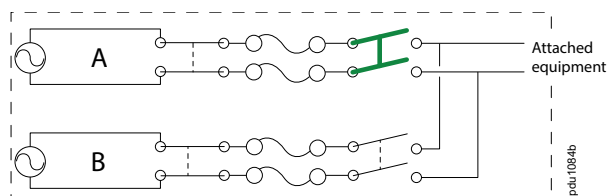

Source B relays are engaged. Source B provides power to the attached equipment.

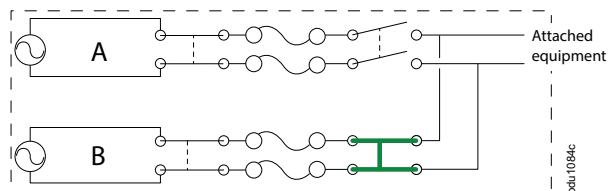

## Types of User Accounts

The Rack ATS has various levels of access (Super User, Administrator, Device User, Read-only User, and Network-only User), which are protected by user name and password requirements. Up to four users are allowed to log on to the same Rack ATS simultaneously.

**NOTE:** You will be prompted to enter a new password the first time you connect to the Rack ATS with the Super User account. The Administrator, Device User, Read-only User, and Network-only User accounts are disabled by default, and cannot be enabled until the Super User default password (**apc**) is changed.

- An Administrator or the Super User can use all of the menus in the Web UI and all of the commands in the CLI. Administrator user types can be deleted, but the Super User cannot be deleted. The default user name and password for the Super User or an Administrator are both **apc**.

**NOTE:** It is recommended that you only use the Super User account to gain initial access to the device. Use the Administrator account for other operations that require this level of access.

**NOTE:** The Super User or an Administrator can manage another Administrator's account (enable, disable, change password, etc).

- A Device User has read and write access to device-related screens. Administrative functions like **Session Management** under the **Security** menu and **Firewall** under **Logs** are unavailable.
- A Read-Only User has access to the same menus as a Device User, but without the ability to change configurations, control devices, delete data, or use file transfer options. Links to configuration options are visible but disabled. The event and data logs display no button to clear the log. The default user name for this account is **readonly**, and the default password is **apc**.
- A Network-Only User (remote user) can only log on using the Web UI and CLI (Telnet or SSH). A network-only user has read/write access to network related menus only.

---

## Watchdog Features

To detect internal problems and recover from unanticipated inputs, the Rack ATS uses internal, system-wide watchdog mechanisms. When it restarts to recover from an internal problem, a “Network Interface Restarted” event is recorded in the Event Log.

### Network Interface Watchdog Mechanism

The Rack ATS implements internal watchdog mechanisms to help protect itself from becoming inaccessible over the network. For example, if the Rack ATS does not receive any network traffic for 9.5 minutes (either direct traffic, such as SNMP, or broadcast traffic, such as an Address Resolution Protocol [ARP] request), it assumes that there is a problem with its network interface and restarts. The network interface watchdog mechanism is only enabled on a Rack ATS that discovers an active network interface connection at start-up.

### Resetting the Network Timer

To help ensure that the Rack ATS does not restart if the network is quiet for 9.5 minutes, the Rack ATS attempts to contact the default gateway every 4.5 minutes. If the gateway is present, it responds to the Rack ATS, and the response restarts the 9.5-minute timer. If your application does not require or have a gateway, specify the IP address of a computer that is running on the network and is on the same subnet. The network traffic of that computer should restart the 9.5-minute timer frequently enough to prevent the Rack ATS from restarting.

# Network Port Sharing (NPS)

You can use the Network Port Sharing feature to view the status of and configure and manage up to 32 Rack ATS units using only one network connection. This is made possible by connecting the Rack ATS units using the Link A and B ports on the front panel of each unit.

**NOTE:** All Rack ATS units in the group must be in the AP44XXA series. The NPS host ATS compares its own firmware version with the versions found on each guest. In the event of a version difference, the host copies its firmware to the non-complying guests by means of the NPS chain.

## Display ID

The display ID is a number, 1 to 32, used to uniquely identify the Rack ATS units in a group. After two or more Rack ATS units are connected to one another in an NPS group, they can be identified on the various interfaces by the use of this “Display ID”. You can view this Display ID in the bottom left corner of the LCD display.

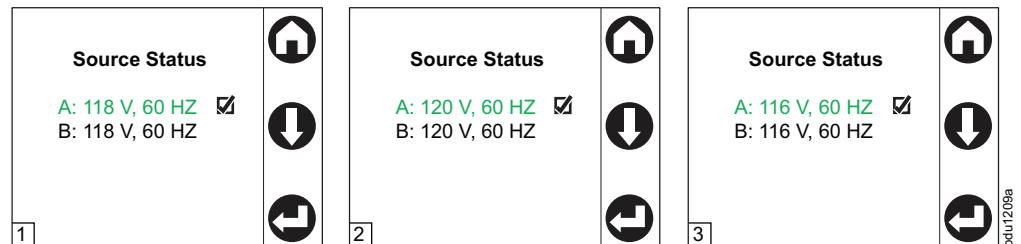

## Install an NPS Group

**NOTE:** To reduce the possibility of communication issues, the maximum total length of cabling (Cat5e+) connecting ATS units in a group should not exceed 10 meters.

**NOTE:** Only one Rack ATS in an NPS group is allowed to be the host. If two host units are connected, one is automatically chosen to be the host for the NPS group. If a guest unit has an active network link, you can select that guest to become the host.

See [Configure NPS Groups](#), page 139 for more details about NPS groups.

Connect up to 32 Rack ATS units using the Link A and B ports on the front panel of each unit. You can assign specific Display IDs by powering up the units manually for the first time in the desired order (1 to 32).

1. Before powering up any of the Rack PDUs connected in a group, determine the Display ID order that you would like.
2. First power up the unit that you would like to have Display ID 1.
3. After that unit has initialized and the LCD has started displaying its screens, power on the unit that you would like to have Display ID 2.
4. Continue in the same way for the remaining units, as applicable for your setup.
5. Connect the Network port of one of the grouped Rack ATS units to a network hub or switch. This unit becomes the host for the Rack ATS group. Guest ATS data can be viewed on the host ATS. Set up network functionality for this Host Rack ATS as specified in the [Establish Network Settings](#), page 19. The host ATS will automatically discover any guest ATS Units connected through the Link A and B ports.

The Rack ATS group is now available from the host unit's IP address. If needed, you can use SNMP OID `ats5gIdentConfigModuleID` to change the NPS IDs. You can change the host unit from the **Configuration > ATS > Groups** page.

The host Rack ATS supports many features that are not supported by NPS guests. These include, but are not limited to:

- SNMP `ats5g` Group OIDs
- Initiating AOS/APP firmware updates for guest ATS units

- Time synchronization for guest ATS units
- Data logging for the guest ATS units

## Specific Assignment of Display IDs

Follow the instructions below before powering up any of the Rack ATS's in the group.

If it is desired to have a specific assignment of Display IDs, this can be achieved by powering up the units for the first time in the desired order, 1 to 32. For example,

1. Before powering up any of the Rack ATS's connected in a group, determine the Display ID order that you would like.
2. First power up the unit that you would like to have Display ID 1.
3. After that unit has initialized and the LCD has started displaying its screens, power on the unit that you would like to have Display ID 2.
4. Continue in the same way for other units, if applicable for your setup.

**NOTE:** The Display ID can be configured only from the CLI interface via the dispID command.

## Firmware Upgrade with NPS

At start-up and routinely during operation, the NPS host compares its own firmware version with the versions found on each guest. In the event of a version difference, the host copies its firmware to the non-complying guests by means of the NPS chain.

**NOTE:** Automatic firmware upgrade is only available for AP44XXA Series Rack ATS units as this functionality requires resident firmware support in both the NPS host and guests. This functionality requires that any replacement Rack ATS units also be AP44XXA Series models to maintain correct operation of the NPS chain.

# Getting Started

To start using the Rack ATS:

1. Install the Rack ATS using the *Installation and Quick Start Manual* on [www.se.com/ww/en/download](http://www.se.com/ww/en/download).
2. Apply power and connect to your network. Follow the directions in the *Installation Manual*.
3. Establish the network settings. See *Establish Network Settings*, page 19
4. Update the ATS firmware. See *Updating Firmware*, page 25.
5. Begin using the Rack ATS with one of the following interfaces:
  - The Display Panel. See *Front Panel Overview*, page 33.  
**NOTE:** The front panel allows you to view Rack ATS settings, but not configure them.
  - The CLI. See *Command Line Interface*, page 40.
  - The Web UI. See *Web User Interface*, page 124.

## Establish Network Settings

EcoStruxure Data Center Expert™ (DCE) provides DHCP configuration for SNMPv1 devices discovered on the DCE private network. If your Rack ATS is connected to a DCE private network, you can disregard this section and use DCE to provide an IP address through the **Private (LAN2) DHCP Discovery** tab in DCE. See your DCE documentation for details.

**NOTE:** You must enable SNMPv1 on the Rack ATS. Establish a local connection to the CLI (Local Access to the CLI, page 23) and use the `snmp` command to enable SNMPv1 (snmp, page 77).

## About IPv4 Setup

You must define three TCP/IP settings for the Rack ATS before it can operate on the network:

- The IP address of the Rack ATS
- The subnet mask of the Rack ATS
- The IP address of the default gateway (only needed if you are going off-segment)

If a default gateway is unavailable, use the IP address of a computer that is located on the same subnet as the Rack ATS and is usually running. The Rack ATS used the default gateway to test the network when traffic is very light.

**NOTE:** Do NOT use the loopback address (127.0.0.1) as the default gateway. Doing so disables the network connection of the Rack ATS. To enable the network connection again, you must log on using a serial connection and reset the TCP/IP settings to their defaults.

For detailed information on how to use a DHCP server to configure the TCP/IP settings on a Rack ATS, see **DHCP Response Options** under *Configure TCP/IP and Communication Settings for IPv4 and IPv6*, page 157.

## About IPv6 Setup

IPv6 network configuration provides flexibility to accommodate your requirements. IPv6 can be used anywhere an IP address is entered on this interface. You can configure IPv6 using the CLI, the Web UI, or DHCP.

## TCP/IP Configuration Methods

Use one of the following methods to define the TCP/IP settings needed by the Rack ATS:

- BOOTP or DHCP server (see [DHCP and BOOTP Configuration](#), page 21).
  - NOTE:** DHCP is the default method of network configuration for the Rack ATS. Most networks are configured with a DHCP server.
- CLI (see [Local Access to the CLI](#), page 23 or [Remote Access to the CLI](#), page 23).
- Device IP Configuration Wizard (see [Device IP Configuration Utility](#), page 20).
  - NOTE:** SNMP is disabled by default, and must be enabled for the Device IP configuration Utility to function. You can enable SNMP from the CLI.
- You can use the .ini file to export .ini file settings from a configured Rack ATS to one or more unconfigured Rack ATS units. To do this from the Web UI, go to **Configuration > General > User Config File**. See [How to Export Configuration Settings](#), page 189 for further options and detailed instructions on how to edit the .ini file.

## Device IP Configuration Utility

SNMP is disabled by default, and must be enabled for the Device IP configuration Utility to function. You can enable SNMP from the CLI. (See [Local Access to the CLI](#), page 23 for instructions to access the CLI. See [snmp](#), page 77 to enable snmp).

The Device IP Configuration Utility can discover Rack ATS units that do not have an IP address assigned. Once discovered, you can configure the IP address settings for the Network Management Cards (NMCs). You can also search for devices already on the network by entering an IP range to define the search. The Utility scans the IP addresses in the defined range and discovers Rack ATS units that already have a DHCP-assigned IP address.

### NOTE:

- For detailed information on the Wizard, see the FAQ article *How do I configure APC Network Management Card network settings?* (FA156064).
- To use the DHCP Option 12, see the FAQ article *Which DHCP options are used when an APC Network Management Device makes a DHCPv4 request?* (FA156110).
- To find an FAQ article, go to [www.se.com](http://www.se.com), and select your location. Then select **Support > Documentation & Software Downloads** and enter the article number or title of the FAQ in the Search bar.

## System Requirements

The Device IP Configuration Utility runs on Microsoft® Windows® 2000, Windows Server® 2003, Windows Server 2012, and on 32- and 64-bit versions of Windows XP®, Windows Vista®, Windows 7, Windows 8, and Windows 10 operating systems. The Device IP Configuration Utility supports Network Management Cards that have firmware version 3.0.x or higher and is for IPv4 only.

## Install the Device IP Configuration Utility

1. Go to the download center at [www.se.com/ww/en/download](http://www.se.com/ww/en/download), click **Select location**, then select your country from the available options.
2. Enter “Network Management Card Device IP Configuration Utility” in the Search bar. Download the latest version of the Network Management Card Device IP Configuration Utility.
3. Extract the .zip file to your desktop, and run the executable file (*DevIPSetup.exe*).

**NOTE:** If you leave the **Start a Web browser when finished** option enabled, you can use **apc** for both the user name and password to access the Rack ATS through your browser.

When Installed, the Device IP configuration Utility is available through the Windows **Start** menu options.

## DHCP and BOOTP Configuration

The default TCP/IP configuration setting, **DHCP**, assumes that a properly configured DHCP server is available to provide TCP/IP settings to the Rack ATS. You can also configure the setting for BOOTP.

A user configuration (INI) file can function as a BOOTP or DHCP boot file.

After configuring the BOOTP or DHCP server, you can log into the CLI (see [Local Access to the CLI](#), page 23 for instructions) and view the IP address assigned to your Rack Monitor 250 (see [View or Configure TCP/IP settings in the CLI](#), page 24 for instructions.)

## DHCP server configuration

You can use an RFC2131/RFC2132-compliant DHCP server to configure the TCP/IP settings for the Rack ATS.

1. The Rack ATS sends out a DHCP request that uses the following to identify itself:
  - A Vendor Class Identifier (APC by default)
  - A Client Identifier (by default, the MAC address of the Rack ATS)
  - A User Class Identifier (by default, the identification of the application firmware installed on the Rack ATS)
  - A Host Name (by default, apcXXYYZZ with XXYYZZ being the last six digits of the Rack ATS serial number). This is known as DHCP Option 12.
2. A properly configured DHCP server responds with a DHCP offer that includes all the settings that the Rack ATS needs for network communication. The DHCP offer also includes the Vendor Specific Information option (DHCP option 43). The Rack ATS can be configured to ignore DHCP offers that do not encapsulate the APC cookie in DHCP option 43 using the following hexadecimal format. (The Rack ATS does not require this cookie by default.)

Option 43 = 01 04 31 41 50 43

- The first byte (01) is the code.
- The second byte (04) is the length.
- The remaining bytes (31 41 50 43) are the APC cookie. See your DHCP server documentation to add code to the Vendor Specific Information option.

**NOTE:** By selecting the **Require vendor specific cookie to accept DHCP Address** check box in the Web UI, you can require the DHCP server to provide an “APC” cookie, which supplies information to the Rack ATS.

For additional information on supported DHCP options, see [Configure TCP/IP and Communication Settings for IPv4 and IPv6](#), page 157.

---

## BOOTP server configuration

For the Rack ATS to use a BOOTP server to configure its TCP/IP settings, it must find a properly configured RFC951-compliant BOOTP server.

1. In the BOOTPTAB file of the BOOTP server, enter the Rack ATS MAC address, IP address, subnet mask, and default gateway, and, optionally, a bootup file name. Look for the MAC address on the bottom of the Rack ATS.
2. Use a serial connection to access the CLI, then enter `-b <bootp>` to enable BOOTP. The default username and password are both **apc**.

See [Local Access to the CLI](#), page 23 for detailed instructions to access the CLI.

3. Enter `-Y` to reboot the Rack ATS.

When the Rack ATS reboots, the BOOTP server provides it with the TCP/IP settings.

- If you specified a bootup file name, the Rack ATS attempts to transfer that file from the BOOTP server using TFTP or FTP. The Rack ATS assumes all settings specified in the bootup file.
- If you did not specify a bootup file name, you can configure the other settings of the Rack ATS remotely through its Web UI or CLI. The default user name and password are **apc** for both interfaces. To create a bootup file, see your BOOTP server documentation.

## Local Access to the CLI

For local access, use a computer that connects to the Rack ATS through the Console port to access the CLI.

**NOTE:** This procedure assumes that a Virtual COM Port (VCP) driver is installed on the computer. If needed, download and install the VCP driver for your operating system from [ftdichip.com](http://ftdichip.com).

1. Open an application to view the COM ports for the computer, according to the instructions for your operating system. (In Windows operating systems, you can view ports in the Device Manager.)
2. Use a Micro USB cable to connect the Console port of the Rack ATS to a USB port on the computer.

A newly occupied serial COM port should appear in the port-viewing application. Take note of the port number or re-assign the port as needed.

3. Run a terminal program (e.g., TeraTerm or PuTTY) and configure the selected serial COM port for 9600 bps, 8 data bits, no parity, 1 stop bit, and no flow control. Use the port to make a serial connection to the Rack ATS.
4. Press ENTER up to three times to display the User Name prompt. Then enter the user name and password.

By default, the user name and password for the Super User are both **apc**. If this is your first log on, you will be prompted to change the default password. It is recommended that you use a strong password which conforms with your company's password requirements.

If you are configuring your network settings for the first time, see [View or Configure TCP/IP settings in the CLI](#), page 24 to complete the configuration.

## Remote Access to the CLI

From any computer on the same network as the Rack ATS, you can use ARP and Ping to assign an IP address to the Rack ATS, and then use SSH or Telnet to access the CLI of that Rack ATS and configure the other TCP/IP settings. By default, SSH is enabled by and Telnet is disabled.

**NOTE:** After the IP address of the Rack ATS is configured, you can access the Rack ATS using SSH or Telnet, without first using ARP and Ping, but SSH is required for initial CLI configuration. You can use the **console** command to enable or disable SSH or Telnet. If needed, you can also use the Web UI to enable or disable SSH or Telnet.

1. Use ARP to define an IP address for the Rack ATS and use the MAC address of the Rack ATS in the ARP command. For example, to define an IP address of 156.205.14.141 for a Rack ATS that has a MAC address of 00 c0 b7 63 9f 67, use one of the following commands:

- Windows command format:  
`arp -s 156.205.14.141 00-c0-b7-63-9f-67`
- LINUX command format: `arp -s 156.205.14.141 00:c0:b7:63:9f:67`

**NOTE:** The MAC address can be found on the bottom of the Rack ATS.

2. Use Ping with a size of 113 bytes to assign the IP address defined by the ARP command. For example:
  - Windows command format: `ping 156.205.14.141 -l 113`
  - LINUX command format: `ping 156.205.14.141 -s 113`
3. Use SSH or Telnet to access the Rack ATS at its newly assigned IP address. (For example: `telnet 156.205.14.141`) Use **apc** for both the user name and password.

See [View or Configure TCP/IP settings in the CLI](#), page 24 to finish the configuration.

## View or Configure TCP/IP settings in the CLI

To view an IP address assigned via DHCP or BOOTP:

1. Log on to the CLI.
2. Enter `tcpip` to view the IPv4 address.  
Enter `tcpip6` to view the IPv6 address.

To assign TCP/IPv4 settings manually:

1. Log on to the CLI.
2. Contact your network administrator to obtain the IP address, subnet mask, and default gateway for the Rack ATS.
3. Use these three commands to configure network settings. (Text in italics indicates a variable.)

```
tcpip -i yourIPAddress
tcpip -s yourSubnetMask
tcpip -g yourDefaultGateway
```

For each variable, type a numeric value that has the format `xxx.xxx.xxx.xxx`. For example, to set a system IP address of 156.205.14.141, type the following command and press ENTER:

```
tcpip -i 156.205.14.141
```

**NOTE:** You can also enter all three command options on the same line:

```
tcpip -i yourIPAddress -s yourSubnetMask tcpip -g
yourDefaultGateway
```

4. Type `exit`, and then press ENTER. The Rack ATS restarts to apply the changes.

To assign TCP/IPv6 settings manually:

1. Log on to the CLI.
2. Contact your network administrator to obtain the IP address, subnet mask, and default gateway for the Rack ATS.
3. Use these three commands to configure network settings. (Text in italics indicates a variable.)

```
tcpip6 -man enable
tcpip6 -i yourIPAddress
tcpip -g yourDefaultGateway
```

**NOTE:** For the IP address and Default Gateway, type a numeric value that has the format `xxxx:xxxx:xxxx:xxxx/xx`.

```
tcpip -d6 DHCPv6 mode
```

Where the DHCPv6 mode can be `router`, `statefull`, `stateless`, or `never`.

4. Type `exit`, and then press ENTER. The Rack ATS restarts to apply the changes.

For more detailed information on `tcpip` commands, see `tcpip`, page 83 or `tcpip6`, page 84.

## .ini File Utility

You can use the `.ini` file export utility to export `.ini` file settings from a configured Rack ATS to an unconfigured Rack ATS. For more information, see **Create and Import Settings with the Config File**.

## Updating Firmware

When you update the firmware on the Rack ATS:

- You obtain the latest bug fixes and performance improvements.
- New features become available for immediate use.

Keeping the firmware versions consistent across your network helps ensure that all Rack ATS units support the same features in the same manner. Here, upgrading simply means placing the firmware file on the Rack ATS; there is no installation required. Check regularly on [www.se.com](http://www.se.com) for any new updates.

## Firmware File Transfer Methods

Obtain the free, latest firmware version from the Schneider Electric website. Enter the model number for your equipment in the Search bar of the website's home page ([www.se.com](http://www.se.com)). Select the desired product from the search results to open that product page. Select the Software & Firmware tab on the product page to view and download any available firmware for that product.

To update the firmware of one or more NMCs **to firmware version 2.5.x or earlier**, use one of these five methods:

- On a Windows operating system, use the **Firmware Update Utility** downloaded from [www.se.com](http://www.se.com). See [Use the Firmware Update Utility](#), page 26.
- On any supported operating system, use **FTP** or **SCP** to transfer the `.nmc3` file. See [Use FTP or SCP to Update One Rack ATS](#), page 27.
- For a Network Management Card that is NOT on your network, use **XMODEM** through a USB virtual communication port via the boot loader to transfer the `.nmc3` file from your computer to the NMC. See [Use XMODEM to Update One Rack ATS](#), page 27.
- Use a **USB drive** to transfer the `.nmc3` file from your computer to the NMC. See [Use a USB Drive To Transfer and Update Files](#), page 28
- For updates to multiple Rack ATS units, see [How To Update Multiple Rack ATS Units](#), page 29.

---

## Use the Firmware Update Utility

This Firmware Update Utility is part of the firmware update package available on [www.se.com/ww/en/download](http://www.se.com/ww/en/download). (*Never use an Update Utility designated for one product to update the firmware of another product*).

**Use the Utility for updates on Windows-based systems.** On any supported Windows operating system, the Firmware Update Utility automates the firmware transfer.

Unzip the downloaded firmware update file and double-click the .exe file. Then enter the IP address, the user name, and the password in the dialog fields and click **Start Update Now**. You can use the **Ping** button to test your entered details.

**Use the Utility for manual updates, primarily on Linux.** On non-Windows operating systems, the Firmware Update Utility extracts the firmware file, but does not upgrade the Rack ATS.

To extract the firmware files:

1. After extracting files from the downloaded firmware upgrade file, run the **Firmware Update Utility** (the .exe file).
2. At the prompts, click **Next>**, then specify the directory location to which the files will be extracted.
3. When the **Extraction Complete** message displays, close the dialog box.

See *Firmware File Transfer Methods*, page 25 for the different upgrade methods after extraction.

## Use FTP or SCP to Update One Rack ATS

### FTP

To use FTP to update a Rack ATS over the network:

- The Rack ATS must be on the network with its system IP, subnet mask, and default gateway configured.
- The FTP server must be enabled at the Rack ATS. You can enable the FTP server under **Configuration > Network > FTP Server**.

To transfer the files:

1. Extract the firmware file.
2. At a computer on the network, open a command prompt window. Go to the directory that contains the firmware files, and list the files:

```
C:\>cd apc
```

```
C:\apc>dir
```

3. Open an FTP client session: `C:\apc>ftp`
4. Type `open` with the IP address of the Rack ATS, and press ENTER. If the **port** setting for the FTP Server has changed from its default of **21**, you must use the non-default value in the FTP command.

- For Windows FTP clients, separate a non-default port number from the IP address by a space. For example (showing a space before 21000):

```
ftp> open 150.250.6.10 21000
```

- Some FTP clients require a colon instead before the port number.

5. Log on as the Super User or Administrator. The default username and password for the Super User are both **apc**.
6. Use the `put` command to send the `.nmc3` file: `put filename.nmc3`  
For example: `put apc_hw21_ats5g_x-x-x-x.nmc3`  
(where `x-x-x-x` is the firmware version number).
7. When FTP confirms the transfer, type `quit` to close the session.

### SCP

To use Secure CoPy (SCP) to update firmware for the Rack ATS, follow these steps:

**NOTE:** As SCP is part of SSH, enabling SSH also enables SCP. SSH is enabled by default.

1. Locate the firmware file.
2. Use an SCP command line to transfer the firmware to the Rack ATS. The following example uses `x-x-x-x` to represent the version number of the firmware:

```
scp -c <cipher> apc_hw21_ats5g_x-x-x-x.nmc3  
apc@158.205.6.185:apc_hw21_ats5g_x-x-x-x.nmc3
```

**NOTE:** This SCP command is for OpenSSH. The command may differ depending on the SSH tool used. `<cipher>` can be either `aes256-cbc` or `3des-cbc`.

## Use XMODEM to Upgrade One Rack ATS

To use XMODEM to upgrade one Rack ATS that is not on the network, you must extract the firmware files from the Firmware Upgrade Utility (see “To extract the firmware files:”).

To transfer the files:

1. Select a serial port at the local computer and disable any service that uses the port.
2. Connect a Micro USB cable to the selected port and to the Console port at the Rack ATS.
3. Run a terminal program such as TeraTerm or HyperTerminal, and configure the selected port for 115200 bps, 8 data bits, no parity, 1 stop bit, and no flow control.
4. Press the **Reset** button on the Rack ATS, then immediately press the **Enter** key twice, or until the Boot Monitor prompt displays: `BM>`
5. Type `XMODEM`, then press **ENTER**.
6. From the terminal program’s menu, select **XMODEM**, then select the `.nmc` firmware file to transfer using `XMODEM`. After the `XMODEM` transfer is completed, the Boot Monitor prompt returns.
7. Type `reset` or press the **Reset** button to restart the Rack ATS’s management interface.

## Use a USB Drive To Transfer and Update Files

Before starting the transfer, make sure the USB drive is formatted in FAT32.

1. Create a folder named **apcfirm** on the USB flash drive.
2. Download the firmware update files and unzip them if needed. Copy the **app.nmc3** firmware file into the **apcfirm** folder.

**NOTE:** Only use firmware applications intended for your device type and NMC.

3. Use a text editor to create a file named **nmc3.rcf** and save it to the **apcfirm** folder. (The file extension must be `.rcf`, not `.txt` for example.)

Add only the following text to the file: `NMC3=application_name.nmc3`, where *application\_name* is filename of the firmware update file.

For example: If the update firmware file is `apc_hw21_ats5g_x-x-x-x.nmc3`, the text file should say `NMC3=apc_hw21_ats5g_x-x-x-x.nmc3`.

Save the changes to the `nmc3.rcf` file.

4. Insert the flash drive into a USB port on your Rack ATS.
5. Use the Web UI, the CLI, or the **Reset** button on the front of the Rack ATS to reboot the management interface. Wait for the reboot to finish.

Check that the update was completed successfully using the procedures in *Verifying Upgrades and Updates*, page 30.

## How To Update Multiple Rack ATS Units

Use one of these methods:

- **Firmware Update Utility:** Use this for multiple firmware updates in IPv4 if you have Windows. The Utility records all update steps in a log as a good reference to validate the update. The Utility is included with your firmware download. For more information, see the following:
  - Use the Firmware Update Utility, page 26, or
  - FAQ article FA156099: *How do I perform a mass firmware upgrade on APC network enabled products?* on [www.se.com](http://www.se.com). To find an FAQ article on [www.se.com](http://www.se.com), enter the title or number of the article in the search bar. On the resulting page, select **Faq** to narrow your search results to only FAQ articles.
- **Export configuration settings:** You can create batch files and use the .ini file utility to retrieve configuration settings from multiple Rack ATS and export them to other Rack ATS Units. For more information on how to download the .ini file utility,
  - See FAQ article FA156117: *How can I mass configure a Network Management Card (NMC) or NMC embedded product?* on [www.se.com](http://www.se.com). To find an FAQ article on [www.se.com](http://www.se.com), enter the title or number of the article in the search bar. On the resulting page, select **Faq** to narrow your search results to only FAQ articles.
  - Read the release notes (release notes are included with the utility file).
- **Use FTP or SCP to update multiple Rack ATS units:** To update multiple Rack ATS Units using an FTP client or using SCP, write a script which automatically performs the procedure.

**NOTE:** To find an FAQ article, go to [www.se.com](http://www.se.com), and select your location. Then select **Support > Documentation & Software Downloads** and enter the article number or title of the FAQ in the Search bar.

## Firmware Upgrade with NPS

At start-up and routinely during operation, the NPS host compares its own firmware version with the versions found on each guest. In the event of a version difference, the host copies its firmware to the non-complying guests by means of the NPS chain.

**NOTE:** Automatic firmware upgrade is only available for AP44XXA Series Rack ATS units as this functionality requires resident firmware support in both the NPS host and guests. This functionality requires that any replacement Rack ATS units also be AP44XXA Series models to maintain correct operation of the NPS chain.

## Verifying Upgrades and Updates

### Verify the Success Or Failure of the Transfer

To verify whether a firmware update succeeded, use the `xferStatus` command in the CLI to view the last transfer result, or use an SNMP GET to the `mfiletransferStatusLastTransferResult` OID.

### Last Transfer Result Codes

Possible transfer errors include the TFTP or FTP server not being found, or the server refusing access, the server not finding or not recognizing the transfer file, or a corrupt transfer file.

SNMP Return Value	Code	Description
1	Successful	The file transfer was successful.
2	Result not available	There are no recorded file transfers.
3	Failure unknown	The last file transfer failed for an unknown reason.
4	Server inaccessible	The TFTP or FTP server could not be found on the network.
5	Server access denied	The TFTP or FTP server denied access.
6	File not found	The TFTP or FTP server could not locate the requested file.
7	File type unknown	The file was downloaded but the contents were not recognized.
8	File corrupt	The file was downloaded but at least one Cyclical Redundancy Check (CRC) failed.

### Verify the Version of Installed Firmware

**Path:** About > Network

Use this Web UI page to verify the version of the updated firmware. You can also use an SNMP GET to the MIB II `sysDescr` OID, or use the `aboutATS` command in the CLI.

## Network Management with Other Applications

These applications and utilities work with a Rack ATS that is connected to the network.

- PowerNet® Management Information Base (MIB) with a standard MIB browser: Perform SNMP SETs and GETs and use SNMP traps.
- EcoStruxure™ IT: Collects, organizes, and distributes critical alerts and key information, providing a unified view of complex physical infrastructure environments from anywhere on the network or from your smart phone.
- Data Center Expert: Collects, organizes, and distributes critical alerts and key information, providing a unified view of complex physical infrastructure environments from anywhere on the network.
- Device IP Configuration Wizard: Configure the basic settings of one or more Rack ATS units over the network.
- Security Wizard: Create components needed to help with security for the Rack ATS units when you are using Secure Sockets Layer (SSL)/Transport Layer Security (TLS) and related protocols and encryption routines.

---

## Recover from a Lost Password

To recover from a lost password, you must reset the Rack ATS to its default configuration. Export the .ini file after configuring your Rack ATS and keep it in a safe place. If you have this file saved, you will be able to retrieve your configuration after a lost password event.

To reset the Rack ATS:

1. On the display interface, hold down the **Reset** button for 20–25 seconds, ensuring the status LED is flashing green during this time. When the status LED changes to orange, release the **Reset** button to allow the Rack ATS to complete its reboot process.
2. Access the Rack ATS through a secure connection with the default username and password (**apc** and **apc**).

Secure connections include a local connection to the CLI by serial cable, a remote connection to the CLI by SSH, or a connection to the web UI by HTTPS. Instructions for each of these secure connections are covered in this manual. Insecure connections are disabled by default.

3. Reset the username and password, then configure the Rack ATS settings as needed.

# Front Panel Overview

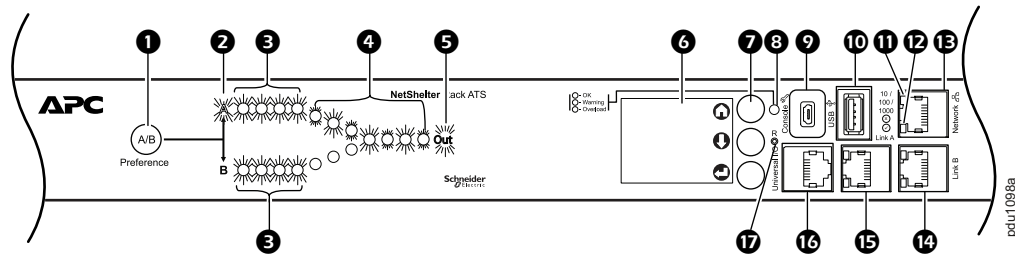

Your Rack ATS is configured so the display backlight turns off after 10 minutes of inactivity. Press any display navigation button to illuminate the backlight.

Item	Function
1 Preference A/B Button	Press to set a preferred power source: the first press sets Source A, the second press sets Source B, and the third press sets no preference.
2 Source A and B LEDs	Indicates preferred power source. If no source is preferred, both LEDs are illuminated. You can also see the Preferred Source on the LCD Display.
3 Input Connector LEDs	Provides information about input voltage from each source. If the RMS input voltage and measured frequency are within the selected tolerance range, the corresponding LED will be illuminated. In a normal operating condition (full source redundancy) both sets of LEDs are illuminated.
4 Output Connector LEDs	Indicates which source is being used for the output (only one path will be illuminated at any time). Together, the Source Preference LEDs, the Connector LEDs, and the Output LED show the power flow through the Rack ATS.
5 Output LED	Shows that voltage is available at the output for the Rack ATS.
6 LCD Display	View Rack ATS status, settings, and product information.
7 Display navigation buttons	On the LCD Display, icons indicate the purpose of adjacent buttons. 🏠 <b>Home:</b> Press to move through monitor screens or return to monitor screens from sub-menus. ⬇️ <b>Down:</b> Press to move through monitor screens or menu items. ⏏️ <b>Select:</b> Press to select menu items or navigate to the main menu from monitor screens.
8 Device Status LED	See Device Status LED, page 34.
9 Console port	Connect your computer to the Rack ATS for local access to the CLI. Use a Micro USB cable (not provided).
10 USB port	Use USB drives for firmware upgrades.
11 10/100/1000 Status LED	See 10/100/1000 Status LED, page 34.
12 Network status LED	See Network Status LED, page 34.
13 Network Port	Connects the Rack ATS to the network using a network cable (not provided).
14 Link A and Link B ports	For use with the Network Port Sharing feature to connect multiple Rack ATS units to one another. Both ports can be used as the In or Out port. A terminator is not required.
15	
16 Universal I/O	Port for connecting an optional APC Temperature Sensor (AP9335T) or an optional APC Temperature/ Humidity Sensor (AP9335TH).
17 Reset switch	Restarts the network and serial communication.

## Device Status LED

This LED identifies the alarm status for the Rack ATS.

Alarms may be related to the ATS hardware (for example, load threshold violations and redundancy loss) or environmental monitoring (for example, temperature threshold violations and sensor communication alarms).

Condition	Description
Solid Green	No Critical or Warning alarms are present.
Solid Yellow	At least one Warning alarm is present, but no Critical alarms are present.
Flashing Red	At least one Critical alarm is present.

## Network Status LED

This LED indicates the network status.





Condition	Description
Off	The Rack ATS is connected to an unknown network.
Solid green	The Rack ATS has valid TCP/IP settings.
Flashing green	The Rack ATS does not have valid TCP/IP settings. <sup>1</sup>
Solid orange	A hardware failure has been detected in the Rack ATS.
Flashing orange	The Rack ATS is making BOOTP requests.
Flashing orange and green (alternating)	The Rack ATS is making DHCP requests.
<sup>1</sup> If you do not use a BOOTP or a DHCP server, see <a href="#">Local Access to the CLI</a> , page 40 or <a href="#">Remote Access to the CLI</a> , page 23 to configure the TCP/IP settings.	

## 10/100/1000 Status LED

This LED indicates the network status of the Rack ATS.

Condition	Description
Off	One or more of the following situations exists: <ul style="list-style-type: none"> <li>The Rack ATS is not receiving input power.</li> <li>The cable that connects the Rack ATS to the network is disconnected or defective.</li> <li>The device that connects the Rack ATS to the network is turned off.</li> <li>The Rack ATS itself is not operating properly. It may need to be repaired or replaced. Contact Customer Support.</li> </ul>
Solid Yellow	The Rack ATS is connected to a network operating at 10–100 Megabits per second (Mbps).
Solid Green	The Rack ATS is connected to a network operating at 1000 Mbps.
Flashing Yellow	The Rack ATS is receiving or transmitting data packets at 10–100 Mbps.
Flashing Green	The Rack ATS is receiving or transmitting data packets at 1000 Mbps.

# LCD Display Screens

The front panel LCD Display automatically rotates between four default screens. You can press Home  or Down  to move through these screens manually. You can press Select  to go to the main menu or select menu items. Down  allows you to move through menu items and menu screens.

After 30 seconds without activity, the LCD display will revert to the default screens. You can also press Home  to return to the default screens.

If the unit is part of an NPS group, the NPS ID appears in the bottom-left corner of the LCD Display.

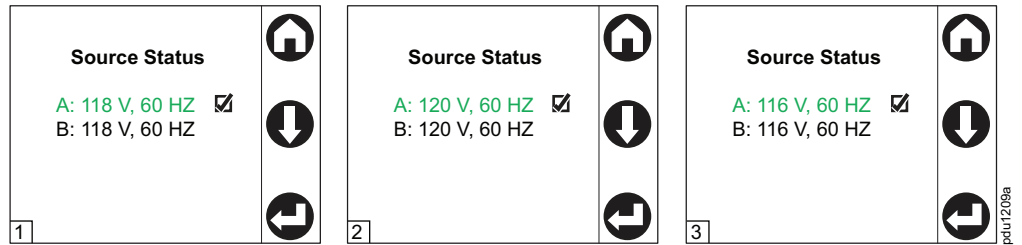

# Default Screens

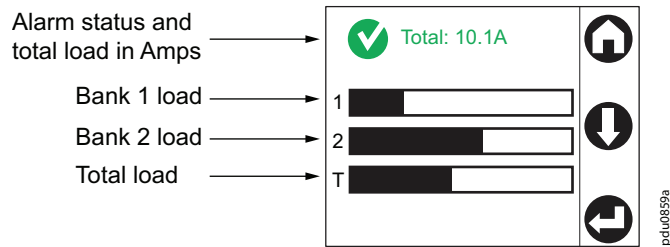
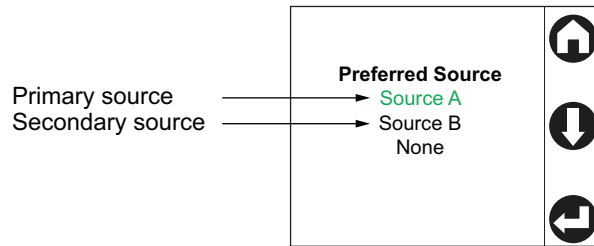
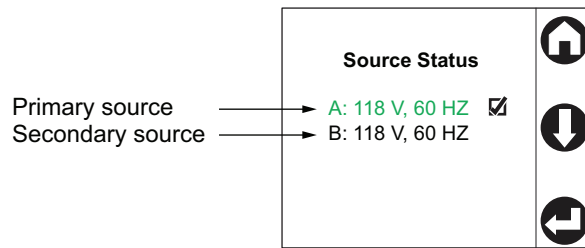
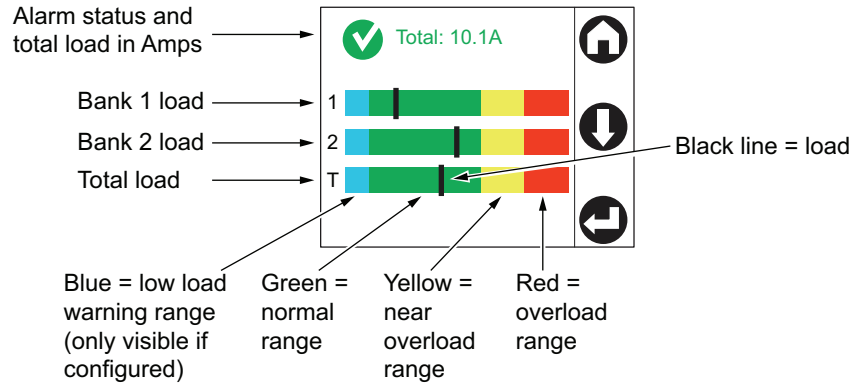

**NOTE:** The number of banks varies by model.

## Menu screens

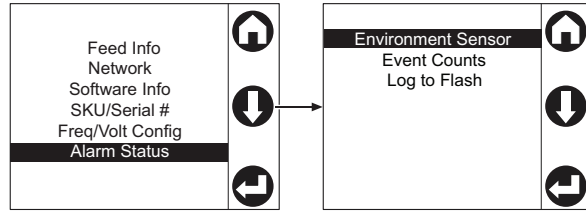

**Feed Info** View information for each power source (Feed A and Feed B), or view the Preferred Source (in green text).

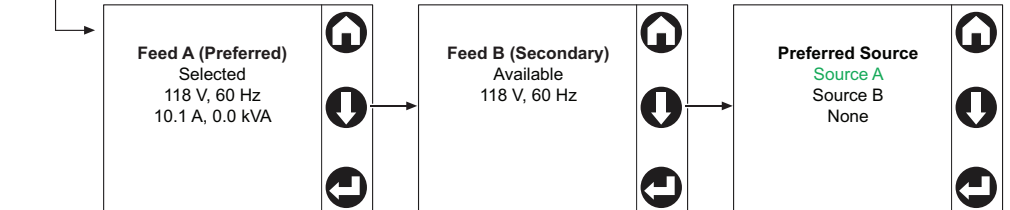

**Network** View the IPv4 Address, the IPv6 Address, or the MAC Address.

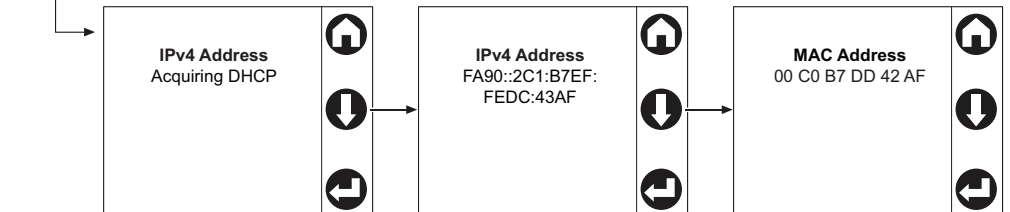

**Software info** View the current software version for each firmware module.

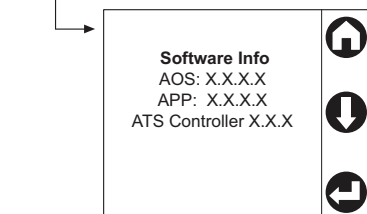

**SKU/Serial#** View the model and serial number for your Rack ATS.

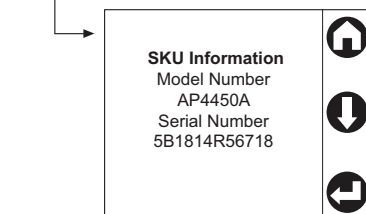

**Freq/Volt Config** Configure the switching behaviour of each active alarm

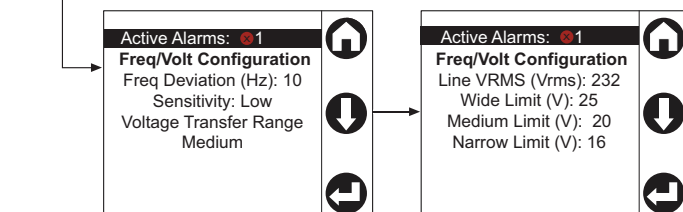

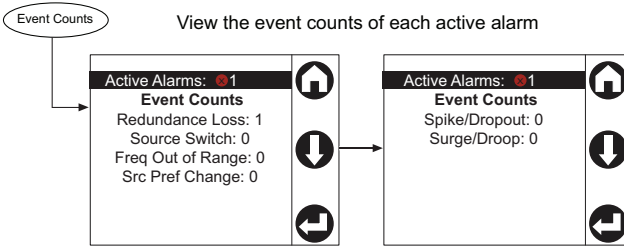
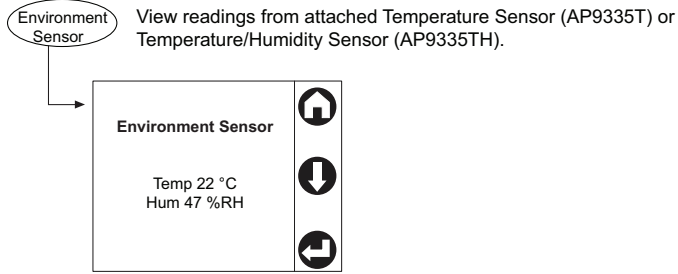
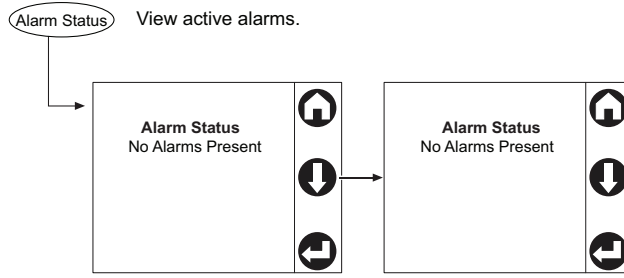

**Log to Flash** Insert a USB drive to the USB port to download compressed log files. Extract the files to your computer to view the logs.

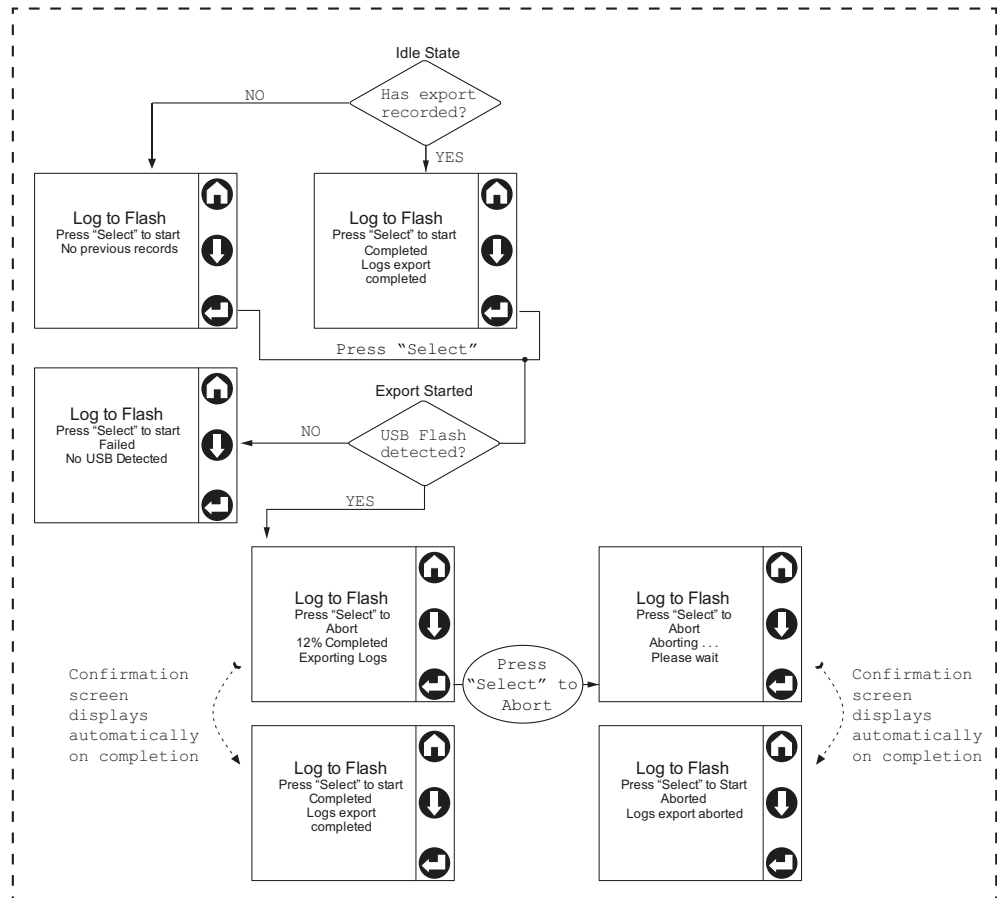

# Alarm Status Indicators

When an alarm is generated, alarm status indicators show the level of the alarm (Warning or Critical).

No Alarm screens	Warning Alarm (Low Load and Near Overload) screens	Critical Alarm (Overload) screens
<p><b>Feed A (Preferred)</b> Selected 118 V, 60 Hz 10.1 A, 0.0 kVA</p>	<p><b>Active Alarms:</b>  1</p> <p><b>Feed A (Preferred)</b> Selected 118 V, 60 Hz 10.1 A, 0.0 kVA</p>	<p><b>Active Alarms:</b>  1</p> <p><b>Feed A (Preferred)</b> Selected 118 V, 60 Hz 10.1 A, 0.0 kVA</p>
<p><b>Alarm Status</b> No Alarms Present</p>	<p><b>Alarm Status</b>  1 Warning Alarm</p>	<p><b>Alarm Status</b>  1 Critical Alarm</p>

pd1408594

---

# Command Line Interface

You can use the Command Line Interface (CLI) to configure, manage, and monitor the status of the Rack ATS (and any connected Rack ATS units if using the Network Port Sharing feature). Additionally, the CLI enables you to create scripts for automated operation. You can configure all parameters of a Rack ATS (including those for which there are not specific CLI commands) by using the CLI to transfer an INI file to the Rack ATS. The CLI uses XMODEM to perform the transfer. However, you cannot read the current INI file through XMODEM.

## Log On to the CLI

To access the CLI, you can use either a local (serial) connection or a remote (Telnet or SSH) connection with a computer on the same network as the Rack ATS.

### Local Access to the CLI

For local access, use a computer that connects to the Rack ATS through the Console port to access the CLI.

**NOTE:** This procedure assumes that a Virtual COM Port (VCP) driver is installed on the computer. If needed, download and install the VCP driver for your operating system from [ftdichip.com](http://ftdichip.com).

1. Open an application to view the COM ports for the computer, according to the instructions for your operating system. (In Windows operating systems, you can view ports in the Device Manager.)
2. Use a Micro USB cable to connect the Console port of the Rack ATS to a USB port on the computer.

A newly occupied serial COM port should appear in the port-viewing application. Take note of the port number or re-assign the port as needed.

3. Run a terminal program (e.g., TeraTerm or PuTTY) and configure the selected serial COM port for 9600 bps, 8 data bits, no parity, 1 stop bit, and no flow control. Use the port to make a serial connection to the Rack ATS.
4. Press ENTER up to three times to display the User Name prompt. Then enter the user name and password.

By default, the user name and password for the Super User are both **apc**. If this is your first log on, you will be prompted to change the default password. It is recommended that you use a strong password which conforms with your company's password requirements.

If you are configuring your network settings for the first time, see [View or Configure TCP/IP settings in the CLI](#), page 24 to complete the configuration.

## Remote Access to the CLI

You can choose to access the CLI through Telnet and/or SSH. SSH is enabled by default. You can use the `console` command to enable or disable either Telnet or SSH. If needed, you can also use the Web UI (under **Configuration > Network > Console > Access** ) to enable or disable Telnet or SSH.

### Telnet for Basic Access

Telnet provides the basic security measure of authentication by user name and password, but not the high-security benefits of encryption. Telnet is disabled by default.

To access the CLI via Telnet:

1. At a command prompt, type `telnet` and the IP address for the Rack ATS (for example, `telnet 139.225.6.133`, when the Rack ATS uses the default Telnet port of 23), and press ENTER.

If the Rack ATS uses a non-default port number (from 5000 to 32768), you must include a colon or a space, depending on your Telnet client, between the IP address (or DNS name) and the port number. (These are commands for general use; some clients do not allow you to specify the port as an argument and some types of Linux might require extra commands).

2. Enter the user name and password. If you cannot remember your user name or password, see the procedure to *Recover from a Lost Password*, page 32.

### SSH for High-security Access

If you use the higher security of SSL/TLS for the Web UI, use SSH for access to the CLI. SSH encrypts user names, passwords, and transmitted data. The interface, user accounts, and user access rights are the same whether you access the CLI through SSH or Telnet, but to use SSH, you must first configure SSH and have an SSH client program installed on your computer. See the *Security Handbook* on [www.se.com](http://www.se.com) for more information on configuring and using SSH. SSH is enabled by default.

## About the Main Screen

The following screen is displayed when you log on to the CLI of a Rack ATS.

```

Schneider Electric                               Network Management Card AOS           vx.x.x.x
(c) Copyright 2024 All Rights Reserved           ATS5G APP                               vx.x.x.x
-----
Name      : Test Lab                               Date      : 3/12/22
Contact   : Don Adams                               Time      : 5:58:30
Location  : Building 3                             User      : Administrator
Up Time   : 0 Days 21 Hours 21 Minutes             Stat      : P+ N4+ N6+ A+
-----
IPv4      : Enabled                               IPv6      : Enabled
Ping response : Enabled
-----
HTTP      : Disabled                               HTTPS     : Enabled
FTP       : Disabled                               Telnet    : Disabled
SSH/SCP   : Enabled                               SNMPv1    : Disabled
SNMPv3    : Disabled
-----
Super User : Enabled                               RADIUS    : Disabled
Administrator : Disabled                         Device User : Disabled
Read-only User : Disabled                       Network-Only User : Disabled

Type ? For command listing
Use tcpip for IP address (-i), subnet (-s), and gateway (-g)

apc >

```

- Two fields identify the operating system (AOS) and application (APP) firmware versions. The application firmware name identifies the type of device that connects to the network (for example, a Rack ATS).

```

Network Management Card AOS           vx.x.x.x
ATS4g APP                             vx.x.x.x

```

- Three fields identify the system name, contact person, and location of the Rack ATS.

```

Name      Test Lab
Contact   Don Adams
Location  : Building 3

```

- An Up Time field reports how long the Rack ATS Management Interface has been running since it was last turned on or reset.

```

Up Time: 0 Days, 21 Hours, 21 Minutes

```

- Two fields identify when you logged in, by date and time.

```
Date: 11/2/2024
Time: 09:06:45
```

- The `User` field identifies whether you logged in through the **Super User**, **Administrator**, **Device User**, **Read-Only**, or **Network-Only** account.

```
User: Administrator
```

- A `Stat` field reports the Rack ATS status.

```
Stat: P+ N4+ N6+ A+
```

P+	The APC Operating System (AOS) is functioning properly.
----	---

IPv4 only	IPv6 only	IPv4 and IPv6*	Description
N+	N+	N4+ N6+	The network is functioning properly.
N?	N6?	N4? N6?	A BOOTP request cycle is in progress.
N-	N6-	N4- N6-	The Rack ATS failed to connect to the network.
N!	N6!	N4! N6!	Another device is using the Rack ATS IP address.

\* The N4 and N6 values can be different from one another: you could, for example, have N4- N6+.

A+	The application is functioning properly.
A-	The application has a bad checksum.
A?	The application is initializing.
A!	The application is not compatible with the AOS.

**NOTE:** If P+ is not displayed, contact the APC Customer Care Center at [www.se.com](http://www.se.com).

- The remaining fields show which protocols and user accounts are enabled.

## Using the CLI

At the CLI, you can use commands to configure the Rack ATS. To use a command, type the command and press ENTER. Commands and arguments are valid in lowercase, uppercase, or mixed case. Options are case-sensitive.

While using the CLI, you can also do the following:

- Type `help` or `?` and press ENTER to view a list of available commands, based on your account type.
- To obtain information about the purpose and syntax of a specified command, type the command, a space, and `help` or `?`. For example, to view RADIUS configuration options, type:  
`radius ?` or `radius help`
- Press the UP arrow key to view the command that was entered most recently in the session. Use the UP and DOWN arrow keys to scroll through a list of up to ten previous commands.
- Type at least one letter of a command and press the TAB key to scroll through a list of valid commands that match the text you have typed in the command line.
- Type `bye`, `exit` or `quit` to close the connection to the CLI.

## Command Syntax

Item	Description
-	Options are preceded by a hyphen.
< >	Definitions of options are enclosed in angle brackets. For example: <code>-dp &lt;device password&gt;</code>
[ ]	If a command accepts multiple options or an option accepts mutually exclusive arguments, the values may be enclosed in brackets.
	A vertical line between items enclosed in brackets or angle brackets indicates that the items are mutually exclusive. You must use one of the items.

### Example of a command that supports multiple options:

```
ftp [-p <port number>] [-S <enable | disable>]
```

In this example, the `ftp` command accepts the option `-p`, which defines the port number, and the option `-S`, which enables or disables the FTP feature.

To change the FTP port number to 5010, and enable FTP:

1. Enter the `ftp` command, the port option, and the argument 5010:  
`ftp -p 5010`
2. After the first command succeeds, enter the `ftp` command, the enable/disable option, and the `enable` selection:  
`ftp -S enable`

### Example of a command that accepts mutually exclusive arguments for an option:

```
alarmcount -p [all | warning | critical]
```

In this example, the option `-p` accepts only three arguments: `all`, `warning`, or `critical`. For example, to view the number of active critical alarms, enter `alarmcount -p critical`

The command will not succeed if you enter an argument that is not specified.

## Command Response Codes

The command response codes enable scripted operations to detect error conditions reliably without having to match error message text.

The CLI reports all command operations with the following format:

```
E [0-9] [0-9] [0-9] : Error message
```

Code	Message
E000	Success
E001	Successfully Issued
E002	Reboot required for change to take effect
E100	Command failed
E101	Command not found
E102	Parameter error (reported when there is any problem with the arguments supplied to the command: too few, too many, wrong type, etc.)
E103	Command Line Error
E104	User Level Denial
E105	Command Prefill
E106	Data Not Available
E107	Serial Communications Lost
E108	EAPoL disabled due to invalid/encrypted certificate
E200	Input error (only reported when an error occurs during the execution of a command)
E201	No Response (reported when a sensor fails to respond)
E206	Invalid value
E213	Device busy or lost communication. Please try again.

## Prompting for User Input during Command Execution

Certain commands require additional user input (for example, transfer .ini prompting for baud rate). There is a fixed timeout period of one minute for such prompts. If you do not enter any text within the timeout period, then the command will print `E100: Command Failed` and the command prompt will display again.

## Command Editing

The Backspace key is the only editing function available during command entry. The Backspace key will delete the last character of the command string you are currently entering.

## History

The CLI implements a command history buffer recalling the 10 previous commands. You can navigate backwards and forwards through entered commands using the Up and Down arrow keys respectively.

## Auto Completion

The CLI supports command auto-completion. If you enter a partial command, you can press the Tab key to complete the command with the first available matched command. If no match exists, the system does not complete the command.

Additional presses of the Tab key will select the next available command match. Once all available commands have been scrolled through, the original, partially entered command displays.

## Delimiter

The CLI uses (ASCII 0x20) as the delimiter between commands and arguments. Extra white space between commands and arguments is ignored.

All fields in command responses are delimited with commas for efficient parsing.

## Options and Arguments Inputs

If you enter a command with *no options* and *no arguments*, the current value of all options available is returned.

If you enter a command with an option and *no arguments*, only the current value of that option is returned.

If you enter a command followed by a question mark (?) or `help`, help text that explains the command is returned.

```
<space> ::= (" " | multiple" ")
<valid letter_number> ::= (a-z | A-Z | 0-9)
<string> ::= (1 - 64 consecutive printable valid ASCII characters
[ranging from hex 0x20 to 0x7E inclusive] )
```

**NOTE:** If the string includes a blank, the entire string **MUST** be surrounded by quotes(" ").

```
<option> ::= "-" (<valid letter_number> | <valid letter_number> <valid
letter_number>)
```

```
<argument> ::= <helpArg> | <alarmcountArg> | <bootArg> | <cdArg> |
<consoleArg> | <dateArg> | <deleteArg> | <ftpArg> | <pingArg> |
<portspeedArg> | <promptArg> | <radiusArg> | <resettodefArg> |
<systemArg> | <tcpipArg> | <userArg> | <webArg> | <string>
```

```
<optionArg> ::= <option> <argument>
```

---

## Response Format and Message Codes

All CLI commands will issue the following:

```
<three digit response code>: <response message>
```

If applicable, the command will also issue `<cr><lf>` and the output of the command.

Successful command operations have a response code of less than 100. Any response code of 100 or greater indicates a failure of some type.

```
E[0-9][0-9][0-9]: Error message
```

**Example:**

```
E000: Success
```

(If applicable, the output of the command is also included.)

# Network Management Card Command Descriptions

## ?

**Access:** Super User, Administrator, Device User, Read-Only User, Network-Only User

**Description:** View a list of all the CLI commands available to your account type. To view help text for a specific command, type the command followed by a question mark.

Argument	Description
<command>	View help text for a specific command.

### Example 1:

```
apc> ?
```

```
System Commands:
```

```
-----
?          about    alarmcount  boot        bye          cd
clrrst     console  date        delete      dir          dns
eapol      email    eventlog    exit        firewall     format
ftp        help     lang        lastrst     ldap         ledblink
logzip     netstat  ntp         ping        portspeed   prompt
pwd        quit     radius      reboot      resetToDef   session
smtp       snmp     snmptrap    snmpv3      ssh          ssl
system     tacacs+  tcpip       tcpip6      user         userauth
userdfilt  web      whoami      wifi        xferINI     xferstatus
```

```
Device Commands:
```

```
-----
aboutATS   atsMeasure  atsStatus   dispID      freqDeviat  eventCounts
frontPanel humAlGen    humLow      humMin      humHyst     humReading
humStatus  lcd         lcdBlink    lineVRMS    modbus      phLowLoad
phNearOver phOverLoad  phPeakLoad  phReading   prodInfo    sensorName
sourceAName sourceB-Name sourcePref  tempAlGen   tempHigh    tempMax
tempHyst   tempPeak    tempReading tempAtatus  vMediumLmt  vNarrowLmt
vSensivty vWideLmt    vXferRange  logToFlash
```

**Example 2:**

```
apc> help boot
Usage: boot - Configuration Options
    boot [-b <dhcpBootp | dhcp | bootp | | manual>] (Boot Mode)
        [-a <remainDhcpBootp | gotoDhcpOrBootp>] (After IP
        Assignment)
        [-o <stop | prevSettings>] (On Retry Fail)
        [-c <enable | disable>] (Require DHCP Cookie)
        [-s <retry then stop#>] (Note: 0 = never)
        [-f <retry then fail#>] (Note: 0 = never)
        [-v <vendor class>]
        [-i <client id>]
        [-u <user class>]
```

**Error Message:** E000, E102

## about

**Access:** Super User, Administrator, Device User, Read-Only User, Network-Only User

**Description:** View hardware and firmware information. This information is useful in troubleshooting and enables you to determine if updated firmware is available at the website.

**Parameters:** None

**Example:**

```
apc> about
      E000: Success
      Hardware
      Factory
      -----
      --
      Model Number:      nnnnnnnnnn
      Serial Number:    nnnnnnnnnn
      Hardware          nnnn
      Revision:
      Manufacture       mm/dd/yyyy
      Date:
      MAC Address:      00 05 A2 18 00 01
      Management        0 Days 1 Hour 42 Minutes
      Uptime:
```

**Error Message:** E000

## alarmcount

**Access:** Super User, Administrator, Device User, Read-Only User, Network-Only User

**Description:** Displays alarms present in the system.

**Parameters:**

Option	Argument	Description
-p	all	View the number of active alarms reported by the Rack ATS. Information about the alarms is provided in the Event Log.
	warning	View the number of active warning alarms.
	critical	View the number of active critical alarms.
	informational	View the number of active informational alarms.

**Example:** To view all active warning alarms, type

```
apc> alarmcount -p warning
E000: Success
WarningAlarmCount: 0
```

**Error Message:** E000, E102

## boot

**Access:** Super User, Administrator, Network-Only User

**Description:** Define how the Rack ATS will obtain its network settings, including the IP address, subnet mask, and default gateway. Then configure the BOOTP or DHCP server settings.

**Parameters:**

Option	Argument	Description
-b <boot mode>	dhcp   bootp   manual	Define how the TCP/IP settings will be configured when the Rack ATS turns on, resets, or restarts.
-c	[<enable   disable> (Require DHCP Cookie)]	dhcp and dhcpBootp boot modes only. Enable or disable the requirement that the DHCP server provide the APC cookie.
The default values for these three settings generally do not need to be changed.		
-v	[<vendor class>]	APC.
-i	[<client id>]	The MAC address of the Rack ATS, which uniquely identifies it on the network.
-u	[<user class>]	The name of the application firmware module.

**Example:** To use a DHCP server to obtain network settings:

1. Type `boot -b dhcp`
2. Enable the requirement that the DHCP server provide the APC cookie:  

```
apc> boot -c enable
E000: Success
```

**Error Message:** E000, E102

## bye

**Access:** Super User, Administrator, Device User , Read-Only User, Network-only User

**Description:** Exit the CLI session. This works the same as the `exit` or `quit` commands.

**Parameters:** None.

**Example:**

```
apc> bye
Connection Closed - Bye
```

**Error Message:** None.

## cd

**Access:** Super User, Administrator, Device User, Read-Only User

**Description:** Navigate to a folder in the directory structure of the Rack ATS. The working directory is set back to the root directory '/' when the you log out of the CLI.

**Parameters:** <directory name>

**Example 1:** To change to the ssh folder and confirm that an SSH security certificate was uploaded to the Rack ATS,

1. Type `cd ssh` and press ENTER.
2. Type `dir` and press ENTER to list the files stored in the SSH folder.

**Example 2:** To return to the previous directory folder, type `cd . .`

**Error Message:** E000, E102

## clrrst

**Access:** Super User, Administrator

**Description:** Clear the network interface reset reason. See `lastrst`, page 65 for more information on the reset reason.

**Example:** None

**Error Message:** None

## console

**Access:** Super User, Administrator

**Description:** Define whether users can access the Command Line Interface using Telnet, which is disabled by default, or Secure SHell (SSH), which is enabled by default and provides protection by transmitting user names, passwords, and data in encrypted form. You can change the Telnet or SSH port setting for additional security. Alternately, disable network access to the Command Line Interface.

**Parameters:**

Option	Argument	Description
-S	<enable   disable>	Enable or Disable SSH access to the device. Enabling SSH enables SCP.
-t	<enable   disable>	Enable or Disable Telnet access to the device.
-pt	<telnet port n>	Define the Telnet port used to communicate with the Rack ATS (23 by default).
-ps	<SSH port n>	Define the SSH port used to communicate with the Rack ATS (22 by default).
-b	2400   9600   19200   38400	Configure the speed of the console port connection (9600 bps by default).

**Example 1:** To enable SSH access to the Command Line Interface, type  
`console -S enable`

**Example 2:** To change the Telnet port to 5000, type  
`console -pt 5000`

**Error Message:** E000, E102

## date

**Access:** Super User, Administrator

**Definition:** Configure the date and time used by the Rack ATS.

**NOTE:** To configure an NTP server to define the date and time for the Rack ATS, see `ntp`, page 70.

**Parameters:**

Option	Argument	Description
-d	<"datestring">	Set the current date. The format must match the current -f setting.
-t	<00:00:00>	Configure the current time, in hours, minutes, and seconds. Use the 24-hour clock format.
-f	mm/dd/yy   dd.mm.yyyy   mmm-dd-yy   dd-mmm-yy   yyyy-mm-dd	Select the numerical format in which to display all dates in this user interface. Each letter m (for month), d (for day), and y (for year) represents one digit. Single-digit days and months are displayed with a leading zero.
-z	<time zone offset>	Set the difference with GMT in order to specify your time zone. This enables you to synchronize with other people in different time zones.

**Example 1:** To display the date using the format yyyy-mm-dd, type

```
date -f yyyy-mm-dd
```

**Example 2:** To define the date as October 30, 2009, using the format configured in the preceding example, type

```
date -d "2009-10-30"
```

**Example 3:** To define the time as 5:21:03 p.m., type

```
date -t 17:21:03
```

**Error Message:** E000, E100, E102

## delete

**Access:** Super User, Administrator

**Description:** Delete a file in the file system. (To delete the eveng log, see `eventlog`, page 61.)

**Parameters:**

Argument	Description
<file name>	Type the name of the file to delete.

**Example:** To delete a file,

1. Navigate to the folder that contains the file. For example, to navigate to the logs folder, type  
`cd logs`
2. To view the files in the logs folder, type  
`dir`
3. To delete a file, type  
`delete <file name>`

**Error Messages:** E000, E102

## dir

**Access:** Super User, Administrator, Device User, Read-Only User, Network-Only User

**Description:** View the files and folders stored on the Rack ATS.

**Parameters:** None

**Example:**

```
apc> dir
E000: Success
1024 Jan 2 4:34 apc_hw21_aos_2.5.0.8.bin
6249332 Jan 2 4:34 apc_hw21_at5g_1.1.0.15.bin
45000 Sep 30 1996 config.ini
      0 Apr 23 18:53 db/
      0 Apr 23 18:53 ssl/
      0 Apr 23 18:53 ssh/
      0 Apr 23 18:53 logs/
      0 Apr 23 18:53 sec/
      0 Apr 23 18:53 fw1/
      0 Apr 23 18:53 email/
      0 Apr 23 18:53 eapol/
      0 Apr 23 18:53 tmp/
      0 Apr 23 18:53 upsfw/
```

**Error Messages:** E000

## dns

**Access:** Super User, Administrator

**Definition:** Configure the manual Domain Name System (DNS) settings.

**Parameters:**

Option	Argument	Description
-OM	enable   disable	Override the manual DNS. When this setting is enabled, configuration data from other sources (typically DHCP) takes precedence over the manual configuration set here.
-y	<enable   disable>	System-hostname sync
-p	<primary DNS server>	Set the primary DNS server.
-s	<secondary DNS server>	Set the secondary DNS server.
-d	<domain name>	Set the domain name.
-n	<domain name IPv6>	Set the domain name IPv6.
-h	<host name>	Set the host name.

**Example:**

```
apc > dns -OM
E000: Success
Override Manual DNS Settings: enabled
```

**Error Message:** E000, E102

## eapol

**Access:** Super User, Administrator

**Description:** Configure EAPoL (802.1X Security) settings.

**Parameters:**

Option	Argument	Description
-s	enable   disable	Enable or disable EAPoL.
-n	<supplicant name>	Set the supplicant name.
-p	<private key passphrase>	Set the private key passphrase.

**Example 1:** To display the result of an `eapol` command:

```
apc>eapol
E000: Success
Active EAPoL
Settings
-----
-----
      Status:          enabled
      Supplicant      NMC-Supplicant
      Name:
      Passphrase:    <hidden>
      CA file         ValidCertificate
      Status
      Private Key     ValidCertificate
      Status
      Public Key      ValidCertificate
      Status
```

**Example 2:** To enable EAPoL:

```
apc>eapol -s enable
E000: Success
Reboot required for change to take effect.
```

## email

**Access:** Super User, Administrator

**Description:** Configure parameters for email, which the Rack ATS uses to send event notifications.

**Parameters:**

Option	Argument	Description
-g[n]	<enable   disable>	Enables (default) or disables sending email to the recipient.
-t[n]	<To Address>	The user and domain names of the recipient. To use email for paging, use the email address for the recipient's pager gateway account (for example, myacct100@skytel.com). The pager gateway will generate the page.
-o[n]	<long   short> (Format)	The long format contains name, location, contact, IP address, serial number of the device, date and time, event code, and event description. The short format provides only the event description.
-l[n]	<Language Code>	The language which the email notification will be sent in. Only English is available at this time.
-r [n]	<Local   recipient   custom> (Route)	<p>Set the SMTP Server options:</p> <p><b>Local</b> (recommended): Choose this option if your SMTP server is located on your internal network, or is set up for your e-mail domain. Choose this setting to limit delays and network outages. If you choose this setting, you must also enable forwarding at the SMTP server of the device, and set up a special external e-mail account to receive the forwarded e-mail. <b>NOTE:</b> Check with your SMTP server administrator before making these changes.</p> <p><b>Recipient:</b> This setting sends email directly to the recipient's SMTP server, which is determined by an MX record lookup of the domain of the To: Address. The device tries only once to send the e-mail. A network outage or a busy remote SMTP server can cause a time-out and cause the e-mail to be lost. This setting requires no additional administrative tasks on the SMTP server. <b>NOTE:</b> When using this setting, the "From Address" will match the "To Address", authentication and encryption (TLS) will be disabled, and port 25 will be used.</p> <p><b>Custom:</b> This setting allows each email recipient to have its own server settings. These settings are independent of the settings given by the <code>smtp</code> command.</p>
Custom Route Option		
-f [n]	<From Address>	<p>The contents of the From field in email messages sent by the Rack ATS in the format <code>user@[IP_address]</code> if an IP address is specified as Local SMTP Server), or in the format <code>user@domain</code> if DNS is configured and the DNS name is specified as Local SMTP Server in the email messages.</p> <p>The local SMTP server may require that you use a valid user account on the server for this setting. See the server documentation.</p>
-s{n}	<SMTP Server>	The IPv4/ IPv6 address or DNS name of the local SMTP server. This definition is required only when the <code>-r</code> option is set to <code>Local</code> .
-p [n]	<Port>	The SMTP port number, with a default of 25. Common ports are 25 for unencrypted e-mail, and 465 and 587 for SSL/TLS encrypted e-mail. You can change the port setting to any port from 1 to 65535.
-a [n]	<enable   disable> (Authentication)	Enable this if the SMTP server requires authentication.
-u [n]	<User Name>	If the SMTP server requires authentication, type the user name and password here. This performs a simple authentication, not SSL/TLS.
-w [n]	<Password>	
-e [n]	<none   ifsupported   always   implicit>	<p>Specify when encryption is used.</p> <p><b>none:</b> The SMTP server does not require or support encryption.</p> <p><b>ifsupported:</b> The SMTP server advertises support for STARTTLS but doesn't require the connection to be encrypted. The STARTTLS command is sent after the advertisement is given. This is typically used with port 25.</p> <p><b>always:</b> The SMTP server requires the STARTTLS command to be sent on connection to the server. This is typically used with port 587.</p>

Option	Argument	Description
		<code>implicit</code> : The SMTP server only accepts connections that begin encrypted. No STARTTLS message is sent to the server. This is typically used with port 465.
<code>-c[n]</code>	<code>&lt;enable   disable &gt;</code>	Require CA Root Certificate: This should be enabled if the security policy of your organization does not allow for implicit trust of SSL/TLS connections. If this is enabled, a valid CA certificate for the SMTP server must be installed to the Rack ATS unit's certificate store using the certificate loader in order for a TLS connection with the SMTP server to succeed.
<code>-i[n]</code>	<code>&lt;Certificate File Name&gt;</code>	This field is dependent on the root CA certificates installed on the Rack PDU and whether or not a root CA certificate is required.
n = Email Recipient Number (1,2,3 or 4)		

**Example:** To enable email to be sent to email recipient 1 with email address `recipient1@apc.com`, using the local SMTP server:

```
apc> email -g1 enable -r1 local -t1 recipient1@apc.com
E000: Success
```

**Error Message:** E000, E102

## eventlog

**Access:** Super User, Administrator, Device User, Read-Only User

**Description:** View the date and time you retrieved the Event Log, the status of the Rack ATS, and the status of sensors connected to the Rack ATS. View the most recent device events and the date and time they occurred. Use the following keys to navigate the Event Log:

**Parameters:**

Key	Description
ESC	Close the Event Log and return to the Command Line Interface.
ENTER	Update the log display. Use this command to view events that were recorded after you last retrieved and displayed the log.
SPACEBAR	View the next page of the Event Log.
B	View the preceding page of the Event Log. This command is not available at the main page of the Event Log.
D	Delete the Event Log. Follow the prompts to confirm or deny the deletion. Deleted events cannot be retrieved.

**Example:**

```
apc> eventlog
---- Event Log -----
Date: 2/9/2024 Time: 13:22:26
-----
Metered Rack ATS: Communication Established
Date      Time      User      Event
-----
2/9/2024  13:17:22  System    Set Time.
2/9/2024  13:16:57  System    Configuration change. Date format
                preference.
2/9/2024  13:16:49  System    Set Date.
2/9/2024  13:16:35  System    Configuration change. Date format
                preference.
2/9/2024  13:16:08  System    Set Date.
2/9/2024  13:15:30  System    Set Time.
2/9/2024  13:15:00  System    Set Time.
2/9/2024  13:13:58  System    Set Date.
2/9/2024  13:12:22  System    Set Date.
2/9/2024  13:12:08  System    Set Date.
2/9/2024  13:11:41  System    Set Date.
<ESC>- Exit, <ENTER>- Refresh, <SPACE>- Next, <D>- Delete
```

**Error Message:** E000, E100

## exit

**Access:** Super User, Administrator, Device User , Read-Only User, Network-only User

**Description:** Exit the CLI session. This works the same as the `bye` or `quit` commands.

**Parameters:** None.

**Example:**

```
apc> exit
Bye
```

**Error Message:** None.

## firewall

**Access:** Super User, Administrator

**Description:** Enable, disable, or configure the internal Rack ATS firewall feature.

**Parameters:**

Parameters	Argument	Description
-S	<enable   disable>	Enable or disable the firewall.
-f	<file name to activate>	Name of the firewall to activate.
-t	<file name to test> <duration time in minutes>	Name of firewall to test and duration time in minutes.
-fe		Shows active file errors.
-te		Shows test file errors.
-c		Cancel a firewall test.
-r		Shows active firewall rules.
-l		Shows firewall activity log.
-Y		Skip firewall test prompt.

**Example:** To enable the firewall policy file *example.fwl*, type

```
apc> firewall -f example.fwl
E000: Success
```

**Error Message:** E000, E102

## format

**Access:** Super User, Administrator

**Description:** Reformat the file system of the Rack ATS and erase all security certificates, encryption keys, configuration settings, and the event and data logs. Be careful with this command.

**NOTE:** You must confirm by entering “YES” when prompted.

**NOTE:** To reset the Rack ATS to its default configuration, use the `resetToDef` command instead.

**Parameters:**

Option	Definition
-f	This will delete all configuration data, event and data logs, certificates and keys. Network settings will NOT be preserved.
-p	This will delete all configuration data, event and data logs, certificates and keys. Network settings WILL be preserved.

**Example:**

```
apc> format -p
```

```
Format FLASH file system
```

```
Warning: This will delete all configuration data,  
         event and data logs, certs and keys.
```

```
All network configuration settings WILL be preserved.
```

```
Enter 'YES' to continue or <ENTER> to cancel: YES
```

**Error Message: None**

## ftp

**Access:** Super User, Administrator

**Description:** Enable or disable access to the FTP server. Optionally, change the port setting to the number of any unused port from 5001 to 32768 for added security.

**NOTE:** The system will reboot if any configuration is changed.

**NOTE:** FTP is disabled by default, and Secure CoPy (SCP) is automatically enabled when the Super User password is set via SSH.

**Parameters:**

Option	Argument	Definition
-p	<port number> (valid ranges are: 21 and 5000-32768)	Define the TCP/IP port that the FTP server uses to communicate with the Rack ATS (21 by default). The FTP server uses both the specified port and the port one number lower than the specified port.
-s	<enable   disable>	Configure access to the FTP server.

**Example:** To change the TCP/IP port to 5001, type

```
apc> ftp -p 5001
E000: Success
```

**Error Message:** E000, E102

## help

**Access:** Super User, Administrator, Device User, Read-Only User, Network-Only User

**Description:** View a list of all the CLI commands available to your account type. To view help text for a specific command, type the command followed by `help`.

**Parameters:** [<command>]

**Example 1:** To view a list of commands available to someone logged on as a Device User, log on to the CLI as the Device User, then type

```
help
```

**Example 2:** To view a list of options that are accepted by the `alarmcount` command, type

```
apc> alarmcount help
Usage: alarmcount -- Display Alarms
      alarmcount [-p <all | warning | critical |
      informational>]
```

## lang

**Access:** Super User, Administrator, Device User

**Description:** Displays the language in use.

**Parameters:** None

**Example:**

```
apc>lang
E000: Success
```

```
Languages
enUs - English
```

**Error Message:** None

## lastrst

**Access:** Super User, Administrator

**Description:** View the last network interface reset reason. Use the output of this command to troubleshoot network interface issues with the guidance of technical support.

Option	Description
02 NMI Reset	The network interface was reset via the Reset button on the Rack ATS front display.
09 Coldstart Reset	The network interface was reset by removing power from the hardware.
12 WDT Reset	The network interface was reset via a firmware command.

**Parameters:** None

**Example:**

```
apc> lastrst
09 Coldstart Reset
E000: Success
```

**Error Message:** E000, E102

## ldap

**Access:** Super User, Administrator, Network-Only User

**Description:** View and configure LDAP settings. You can set up the device to use an LDAP server to authenticate remote users. Two common examples are Microsoft Active Directory and OpenLDAP. Authentication is always performed using a simple bind request over a TLS connection. Ensure that the LDAP server's CA certificate is installed in order for the TLS connection to the LDAP server to complete.

Option	Argument	Description
-s	<Search User URI>	<p>An LDAP URI representing the location of a user object to initially bind to. This user object must have permission to search the LDAP database for users. During a user login attempt, the LDAP server in this URI is connected to and a bind to the DN is performed with the password provided in -p (Search User Password). If this bind is successful, the user attempting to login is then searched for.</p> <p>This LDAP URI must include a scheme of either "ldap" or "ldaps". When "ldaps" is used, then the TLS connection is implicit and the TCP connection defaults to using port 636. When "ldap" is used, then the TLS connection is initiated by sending a StartTLS request and the TCP connection defaults to using port 389. Use of "ldaps" is non-standard and discouraged.</p> <p>This LDAP URI may include the address of the LDAP server and optionally the port number. The DN of the search user object follows. If the search user DN ends with DC components, then a DNS lookup of the SRV record for the LDAP service at this domain is performed. If the SRV record is found, then it is used instead of the host specified in the URI. If the SRV record is not found, then the host specified in the URI is used. The host component of the URI may be omitted if the SRV record for LDAP is known to exist.</p> <p>If the DN is omitted, then the host component must be present, and an anonymous bind is performed.</p> <p>Examples:</p> <ul style="list-style-type: none"> <li>• <b>ldap://ldap.domain.com/CN=searchuser,OU=users,DC=domain,DC=com</b> If DNS is available, a DNS lookup of the SRV record for the LDAP service at domain.com is performed. If it is found, then it is connected to. If it is not found, then "ldap.domain.com" at port 389 is connected to. TLS is then established after sending a StartTLS request, and then a bind to the object "CN=searchuser,OU=users,DC=domain,DC=com" with the password specified in -p (Search User Password) is performed. From here a search for the user logging in is performed.</li> <li>• <b>ldap:///CN=searchuser,OU=users,DC=domain,DC=com</b> If DNS is available, a DNS lookup of the SRV record for the LDAP service at domain.com is performed. If it is found, then it is connected to. If it is not found, then no connection is made because the host component of the URI is omitted and LDAP authentication cannot proceed. If the connection is successful, then StartTLS, bind, and search are performed as described above.</li> <li>• <b>ldaps://ldap.domain.com</b>"ldap.domain.com" at port 636 is connected to and a TLS handshake is immediately performed without sending a StartTLS request. If this succeeds, then an anonymous bind is performed. From here a search for the user logging in is performed.</li> <li>• <b>ldap://ldap.domain.com:42/CN=searchuser,OU=users,DC=domain,DC=com</b> This is the same as the first example except that if the SRV record is not found then "ldap.domain.com" at port 42 is connected to.</li> </ul>
-p	<Search User Password>	The password to use in the initial bind request to the search user as described above. If left blank, then either an anonymous or unauthenticated bind is performed depending on whether or not a search user DN is provided.
-t	<2 - 60>	The timeout in seconds to use when connecting to and communicating with the LDAP server. The initial TCP connection must complete within this amount of time. If it does, then each LDAP response from the server must be

Option	Argument	Description
		received within this amount of time following each LDAP request. Because a single LDAP authentication can consist of multiple requests (and even to multiple servers if referrals are chased), the overall authentication time may end up being much longer than the timeout value specified here.
-u	<Users Base DN>	This is the DN of the base object entry under which all users who login must exist.
-g	<Groups Base DN>	This is the DN of the base object entry under which the user groups specified in the following settings must exist.
-g	<Groups Base DN>	This is the DN of the base object entry under which the user groups specified in the following settings must exist.
-ag	<Admins Group Name>	This is the common name (CN) of the LDAP group to which NMC Administrators are members of. If the user logging in is a member of this group, then the user is granted Administrator access.
-dg	<Device Users Group Name>	This is the common name (CN) of the LDAP group to which NMC Device Users are members of. If the user logging in is a member of this group, then the user is granted Device User access.
-ng	<Network Users Group Name>	This is the common name (CN) of the LDAP group to which NMC Network Users are members of. If the user logging in is a member of this group, then the user is granted Network User access.
-rg	<Read Only Users Group Name>	This is the common name (CN) of the LDAP group to which NMC Read Only Users are members of. If the user logging in is a member of this group, then the user is granted Read Only User access.
-ad	<enable   disable>	If this is enabled, then LDAP directories containing users of the "User" class and groups of the "Group" class following the standard Active Directory schema will be supported.
-posix	<enable   disable>	If this is enabled, then LDAP directories containing users of the "posixAccount" class and groups of the "posixGroup" class following the schema defined in RFC 2307 will be supported.
-4519	<enable   disable>	If this is enabled, then LDAP directories containing users of the "uidObject" class and groups of either the "groupOfNames" class or the "groupOfUniqueNames" class following the schema defined in RFC 4519 will be supported.
-2798	<enable   disable>	If this is enabled, then LDAP directories containing users of the "inetOrgPerson" class as defined in RFC 2798 will be supported.
-cuser	<enable   disable>	If this is enabled, then LDAP directories containing users of classes that do not conform to any of the supported classes above can be supported. When this is enabled, the settings -ucn (Custom User Class Name) and -ucua (Custom User Username Attr) must be provided, and -ucga (Custom User Group Number Attr) may optionally be provided.
-cgroup	<enable   disable>	If this is enabled, then LDAP directories containing groups of classes that do not conform to any of the supported classes above can be supported. When this is enabled, the settings -gcn (Custom Group Class Name) and -gcma (Custom Group Member Attr) must be provided, and -gcga (Custom Group Group Number Attr) may optionally be provided. -gcmt (Custom Group Member Type) must also be set correctly.
-ucn	<Custom User Class Name>	This is the name of the object class that user entries belong to. It is only used when -cuser (Custom User Class) is enabled.

Option	Argument	Description
-ucua	<Custom User Username Attr>	This is the name of the attribute that contains a user's username for the object class specified by -ucn (Custom User Class Name). It is only used when -cuser (Custom User Class) is enabled.
-ucga	<Custom User Group Number Attr>	This is the name of the attribute that contains the group number for a user's primary group for the object class specified by -ucn (Custom User Class Name). This is optional, and only used when -cuser (Custom User Class) is enabled. It is used the same way as the "gidNumber" attribute in the "posixAccount" class.
-gcn	<Custom Group Class Name>	This is the name of the object class that group entries belong to. It is only used when -cgroup (Custom Group Class) is enabled.
-gcma	<Custom Group Member Attr>	This is the name of the attribute that contains the members of the group for the object class specified by -gcn (Custom Group Class Name). It is only used when -cgroup (Custom Group Class) is enabled. When -gcmt (Custom Group Member Type) is set to DN, then the values in this attribute are DNs. When it is set to username, then the values in this attribute are user names.
-gcga	<Custom Group Group Number Attr>	This is the name of the attribute that contains the group number of the group for the object class specified by -gcn (Custom Group Class Name). This is optional, and only used when -cgroup (Custom Group Class) is enabled. It is used the same way as the "gidNumber" attribute in the "posixGroup" class.
-gcmt	<DN   user name>	This specifies how members of the group for the object class specified by -gcn (Custom Group Class Name) are specified. It can be set to either DN or username.

**Example 1:** To view the existing LDAP settings for the NMC, type:

```
ldap
```

**Example 2:** To configure LDAP to connect to an LDAP server using only an Active Directory schema at ldap.company.com (or to use the ldap SRV record at company.com if available) with a timeout of five seconds, and bind with an initial user with search privileges at DN cn=admin, dc=company, dc=com with password "password", with NMC administrators in the nmc-admins group, NMC read-only users in the nmc-ro-users group, and network only and device only users disabled, type:

```
ldap -s ldap://ldap.company.com/cn=admin,dc=company,dc=com -p
password -t 5 -u ou=users,dc=company,dc=com -g ou=groups,dc=
company,dc=com -ag nmc-admins -rg nmcro-users -dg "" -ng "" -ad
enable -posix disable -4519 disable -2798 disable -cuser
disable -cgroup disable
```

## ledblink

**Access:** Super User, Administrator

**Description:** Sets the status LED to blink for the specified amount of time. Use this command to help visually locate the Rack ATS.

**Parameters:**

Argument	Definition
<time>	Number of minutes to blink the LED.

**Example:**

```
apc> ledblink 1
E000: Success
```

**Error Message:** E000, E102

## logzip

**Access:** Super User, Administrator

**Description:** Creates a single, compressed archive of the log files available from the NMC and Rack ATS. These files can be used by technical support to troubleshoot issues.

**Parameters:**

Option	Argument	Definition
-m	<email recipient> (1-4)	The identifying number (1-4) of the email recipient to which the zip file will be sent. Enter the number of one of the four possible email recipients configured.

**Example:**

```
apc> logzip -m 1
Generating files
/dbg/debug_ZA1023006009.tar
Emailing log files to email recipient - 1
E000: Success
```

**Error Message:** E000, E102

## netstat

**Access:** Super User, Administrator

**Description:** View the status of the network and all active IPv4 and IPv6 addresses.

**Parameters:** None

**Example:**

```
apc> netstat
Current IP Information:
Family    mHome    Type      IPAddress      Status
IPv6      4        auto      FE80::2C0:B7FF:FE51:
           F304/64
IPv6      0        manual    ::1/128        configured
IPv4      0        manual    127.0.0.1/32   configured
```

**Error Message:** E000, E10

## ntp

**Access:** Super User, Administrator

**Description:** View and configure the Network Time Protocol parameters.

**Parameters:**

Option	Argument	Definition
-OM	enable   disable	Override the manual settings.
-p	<primary NTP server>	Specify the primary server.
-s	<secondary NTP server>	Specify the secondary server.
-e	enable   disable	Enable or disable the use of NTP.
-u	<update now>	Immediately update theRack ATS time from the NTP server.

**Example 1:** To enable the override of manual setting, type  
ntp -OM enable

**Example 2:** To specify the primary NTP server, type  
ntp -p 150.250.6.10

**Error Message:** E000, E102

## ping

**Access:** Super User, Administrator, Device User, Network-Only User

**Description:** Determine whether the device with the IP address or DNS name you specify is connected to the network. Four inquiries are sent to the address.

**Parameters:**

Option	Argument	Description
n/a	<IP address or DNS name>	Type an IP address with the format xxx.xxx.xxx.xxx, or the DNS name configured by the DNS server.
-t		Ping until stopped.

**Example:** To determine whether a device with an IP address of 192.168.1.50 is connected to the network, type

```
apc> ping 192.168.1.50
E000: Success
Reply from 192.168.1.50: time (ms) = <10
Reply from 192.168.1.50: time (ms) = <10
Reply from 192.168.1.50: time (ms) = <10
Reply from 192.168.1.50: time (ms) = <10
```

**Error Message:** E000, E100, E102

## portSpeed

**Access:** Super User, Administrator, Network-Only User

**Description:** Define the communication speed of the Ethernet port.

**NOTE:** The Port Speed setting can be changed to 1000 Mbps. However, this change can only be made via the Web UI.

**Parameters:**

Option	Arguments	Description
-s	auto   10H   10F   100H   100F	<p>auto enables the Ethernet devices to negotiate to transmit at the highest possible speed.</p> <p>H = Half Duplex (communication in only one direction at a time)</p> <p>F = Full Duplex (communication in both directions simultaneously)</p> <p>10 = 10 Megabits</p> <p>100 = 100 Megabits</p>

**Example:** To configure the TCP/IP port to communicate using 100 Mbps with half-duplex communication, type

```
apc> portspeed -s 100H
E000: Success
Reboot required for change to take effect.
```

**Error Message:** E000, E102

## prompt

**Access:** Super User, Administrator, Device User, Network-Only User

**Description:** Configure the command line interface prompt to include or exclude the account type of the currently logged-in user. Any user can change this setting; all user accounts will be updated to use the new setting.

**Parameters:**

Option	Argument	Description
-s	long	The prompt includes the account type of the currently logged-in user.
	short	The default setting. The prompt is four characters long: apc>

**Example:**

```
apc> prompt -s long
E000: Success
```

```
Administrator@apc>prompt -s short
E000: Success
```

**Error Message:** E000, E102

## pwd

**Access:** Super User, Administrator, Device User, , Read-Only User, Network-Only User

**Description:** Output the path of the current working directory.

**Parameters:** None

**Example:**

```
apc> pwd
/
```

```
apc> cd logs
E000: Success
```

```
apc> pwd
/logs
```

**Error Message:** E000, E102

## quit

**Access:** Super User, Administrator, Device User ,, Read-Only User, Network-only User

**Description:** Exit the CLI session. This works the same as the `exit` or `bye` commands.

**Parameters:** None.

**Example:**

```
apc> quit
Bye
```

**Error Message:** None.

## radius

**Access:** Super User, Administrator, Network-Only User

**Description:** View the existing RADIUS settings and configure basic authentication parameters for up to two RADIUS servers. Additional authentication parameters are available in the Web UI.

For detailed information about configuring your RADIUS server, see the Network Management Card 3 Security Handbook.

**Parameters:**

Option	Argument	Description
-a	<local   radiusLocal   radius>	Configure RADIUS authentication:  local = RADIUS is disabled. Local authentication is enabled.  radiusLocal = RADIUS, then Local Authentication. RADIUS and local authentication are enabled. Authentication is requested from the RADIUS server first. If the RADIUS server fails to respond, local authentication is used.  radius = RADIUS is enabled. Local authentication is disabled.
-p1 -p2	<server IP>	The server name or IP address of the primary or secondary RADIUS server.
-o1 -o2	<port>	The port number of the primary or secondary RADIUS server.  <b>NOTE:</b> RADIUS servers use port 1812 by default to authenticate users. The Rack ATS supports ports 1 to 65535.
-s1 -s2	<server secret>	The shared secret between the primary or secondary RADIUS server and the Rack ATS.
-t1 -t2	<server timeout>	The time in seconds that the Rack ATS waits for a response from the primary or secondary RADIUS server.

**Example 1:** To view the existing RADIUS settings for the Rack ATS, type `radius` and press ENTER.

**Example 2:** To configure a 10-second timeout for a secondary RADIUS server, type  

```
apc> radius -t2 10
E000: Success
```

**Error Message:** E000, E102

## reboot

**Access:** Super User, Administrator, Network-Only User

**Description:** Restart the network management interface of the Rack ATS only. This does not affect the output power of the Rack ATS.

Option	Description
-Y	Skip confirmation prompt (Uppercase Y only)

**Example 1:**

```
apc> reboot
E000: Success
Reboot Management Interface
Enter 'YES' to continue or <ENTER> to cancel: YES
Rebooting...
```

**Example 2:**

```
apc> reboot -Y
E000: Success
Reboot Management Interface
Rebooting...
```

**Error Message:** E000, E100

## resetToDef

**Access:** Super User, Administrator

**Description:** Reset all configurable parameters to their defaults. Delete all accounts and clear Event and Data Logs.

**NOTE:** Certain non-configurable parameters are not reset using `resetToDef`, and can only be erased from the Rack ATS by formatting the file system using the `format` command.

**Parameters:**

Option	Arguments	Description
-p	all   keepip	Caution: This resets all configurable parameters to their defaults.  all = Reset all configuration changes, including event actions, device settings, and TCP/IP settings.  keepip = Reset all configuration changes, <i>except</i> for the TCP/IP settings.

**Example:** To reset all of the configuration changes *except* the TCP/IP settings, type

```
apc> resettodef -p keepip
Reset to Defaults Except TCP/IP
Enter 'YES' to continue or <ENTER> to cancel: YES
```

**Error Message:** E000, E100

## session

**Access:** Super User, Administrator

**Description:** Records who is logged in (user), the interface, the address, time and ID.

**Parameters:**

Option	Arguments	Description
-d	[-d <session nID>] (Delete)	Delete the session for the current user with the specified session ID.
-m	<enable   disable> (MultiUser Enable)	Enable to allow two or more users to log on at the same time. Disable to allow only one user to log in at a time.
-a	<enable   disable> (Remote Authentication Override)	The Rack ATS supports RADIUS storage of passwords on a server. Enable Remote Authentication Override to allow a local user to log on using a username and password for the Rack ATS that is stored locally on the Rack ATS.

**Example:**

```
apc> session
User   Interface  Address          Logged In Time   ID
-----
apc    Telnet     10.169.118.1-   00:00:03        19
00
E000: Success
```

**Error Message:** E000, E102

## smtp

**Access:** Super User, Administrator, Network-Only User

**Description:** Configure the settings for the local e-mail server.

**Parameters:**

Option	Arguments	Description
-f	<From Address>	The address from which e-mail will be sent by the Rack ATS.
-s	<SMTP Server>	The IPv4/IPv6 address or DNS name of the local SMTP server.
-p	<Port>	The SMTP port number, 25 by default. Common ports are 25 for unencrypted e-mail, and 465 and 587 for SSL/TLS encrypted e-mail. You can change the port setting to any port from 1 to 65535.
-a	<enable   disable>	Enable this if your SMTP server requires authentication.
-u	<User Name>	If the SMTP server requires authentication, type the user name and password here.
-w	<Password>	
-e	<none   ifavail   always   implicit>	<p>Encryption options:</p> <p><i>none</i>: The SMTP server does not require/support encryption.</p> <p><i>ifavail</i>: The SMTP server advertises support for STARTTLS but does not require the connection to be encrypted. The STARTTLS command is sent after the advertisement is given. This is typically used with port 25.</p> <p><i>always</i>: The SMTP server requires the STARTTLS command to be sent upon connection to the server. This is typically used with port 587.</p> <p><i>implicit</i>: The SMTP server only accepts connections that begin encrypted. No STARTTLS message is sent to the server. This is typically used with port 465.</p>
-c	<enable   disable>	<p>Require CA Root Certificate.</p> <p>This should be enabled if the security policy of your organization does not allow for implicit trust of SSL/TLS connections. If this is enabled, a valid CA certificate for the SMTP server must be installed to the Rack ATS unit's certificate store using the certificate loader in order for a TLS connection with the SMTP server to succeed.</p>
-i	<certificate file name>	The file name of the certificate.

**Example:**

```
apc> smtp
E000: Success
```

```
From:          address@example.com
Server:        mail.example.com
Port:          25
Auth:          disabled
User:          User
Password:      <not set>
Encryption:    none
Req. Cert:     disabled
Cert File:     <n/a>
```

**Error Message:** E000, E102

## snmp

**Access:** Super User, Administrator, Network-Only User

**Description:** Enable or disable and configure SNMPv1.

**NOTE:** SNMPv1 is disabled by default. The Community Name (`-c [n]`) must be set before SNMPv1 communications can be established.

**Parameters:**

Option	Arguments	Description
<code>-S</code>	<code>&lt;enable   disable&gt;</code>	Enable or disable SNMPv1
<code>-c [n]</code>	<code>&lt;Community&gt;</code>	Specify a community name or string.
<code>-a [n]</code>	<code>&lt;read   write   writeplus   disable&gt;</code>	Indicate the usage rights.
<code>-n [n]</code>	<code>&lt;IP or Domain Name&gt;</code>	Specify the IPv4/IPv6 address or the domain name of the Network Management Station.

[n] = the access control number: 1,2,3, or 4.

**Example:** To enable SNMP version1, type

```
apc> snmp -S enable
E000: Success
Reboot required for change to take effect.
```

**Error Message:** E000, E102

## snmpv3

**Access:** Super User, Administrator

**Description:** Enable or disable and configure SNMPv3.

**NOTE:** SNMPv3 is disabled by default. A valid user profile must be enabled with passphrases (`-a[n]`, `-c[n]`) set before SNMPv3 communications can be established.

**Parameters:**

Option	Arguments	Description
<code>-s</code>	<code>&lt;enable   disable&gt;</code>	Enable or disable SNMPv3
<code>-u[n]</code>	<code>&lt;User Name&gt;</code>	Specify a user name, an authentication phrase and encryption phrase.
<code>-a[n]</code>	<code>&lt;Auth phrase&gt;</code>	
<code>-c[n]</code>	<code>&lt;Crypt phrase&gt;</code>	
<code>-ap[n]</code>	<code>&lt;sha   md5   none&gt;</code>	Indicate the type of authentication protocol.
<code>-pp[n]</code>	<code>&lt;aes   des   none&gt;</code>	Indicate the privacy (encryption) protocol.
<code>-ac[n]</code>	<code>&lt;enable   disable&gt;</code>	Enable or disable access.
<code>-au[n]</code>	<code>&lt;User profile name&gt;</code>	Give access to a specified user profile.
<code>-n[n]</code>	<code>&lt;IP or Domain Name&gt;</code>	Specify the IPv4/IPv6 address or the hostname for the Network Management Station.
[n] = Access Control # = 1, 2, 3, through 8		

**Example:** To give access level 2 to user “JMurphy”, type

```
apc> snmpv3 -au2 "JMurphy"
E000: Success
```

\*Reboot required for change to take effect

**Error Message:** E000, E102

## snmptrap

**Access:** Super User, Administrator, Network-Only User

**Description:** Enable or disable SNMP trap generation

**Parameters:**

Option	Arguments	Description
<code>-c[n]</code>	<code>&lt;Community&gt;</code>	Specify a community name or string.
<code>-r[n]</code>	<code>&lt;Receiver NMS IP&gt;</code>	The IPv4/IPv6 address or host name of the trap receiver.
<code>-l[n]</code>	<code>&lt;Language code&gt;</code>	Specify a language. English ( <code>enUS</code> ) is the only available option at this time.
<code>-t[n]</code>	<code>[snmpV1   snmpV3]</code>	Specify the trap type: SNMPv1 or SNMPv3.
<code>-p[n]</code>	<code>&lt;Port&gt;</code>	Specify the SNMP trap port number for this trap receiver (162 by default). The range is 1 to 65535.
<code>-g[n]</code>	<code>[enable   disable]</code>	Enable or disable trap generation for this trap receiver. Enabled by default.
<code>-a[n]</code>	<code>[enable   disable]</code>	Enable or disable authentication of traps for this trap receiver, SNMPv1 only.

Option	Arguments	Description
-u[n]	<profile1   profile2   profile3   profile4>	Select the identifier of the user profile for this trap receiver, SNMPv3 only.
n = Trap receiver # = 1, 2, 3, 4, 5, or 6		

**Example:** To enable and configure an SNMPv1 trap for Receiver 1, with the Community Name of public, receiver 1 IP address of 10.169.118.100, using the default English language, type

```
apc> snmptrap -cl public -r1 10.169.118.100 -ll enUS -tl snmpV1
-g1 enable
E000: Success
```

**Error Message:** E000, E102

## ssh

**Access:** Super User, Administrator, Network-Only User

**Description:** Show, delete, and generate SSH server keys.

**NOTE:** You must use the `ssh key` command to use the options below.

**Parameters:**

Option	Argument	Description
-s		Display the current SSH server key in use.
-f		Display the current SSH server key's fingerprint.
-d		Delete the current SSH server key in use.
-i	<filename>.p15	Import the SSH server key from a PKCS #15 file.
-ecdsa	<256> (bit size)	Generate an Elliptic Curve Digital Signature Algorithm (ECDSA) SSH server key with the specified size in bits.
-rsa	<1024   2048   4096>(bit size)	Generate a Rivest–Shamir–Adleman (RSA) SSH server key with the specified size in bits.

**Example 1:** To delete the SSH server key, type

```
apc> ssh key -d
E000: Success
```

**Example 2:** To import the SSH server key from a .p15 file generated by the NMC Security Wizard CLI Utility, type

```
apc> ssh key -i nmc.p15
E000: Success
```

**Error Messages:** E000, E102

## ssl

**Access:** Super User, Administrator, Network-Only User

**Description:** Configure and manage the Rack ATS unit's public key and Web UI certificate, and create a Certificate Signing Request (CSR).

**NOTE:** There are three sets of options for this command, indicated below (*key*, *csr*, and *cert*).

### Configure public keys (*key*):

Option	Argument	Description
-s		Display the current public key in use.
-d		Delete the current public key in use.
-i	<filename>.p15	Import the public key from a PKCS #15 file.
-ecdsa	<256   384   521>	Generate an Elliptic Curve Digital Signature Algorithm (ECDSA) public key with the specified size in bits.
-rsa	<1024   2048   4096>	Generate a Rivest–Shamir–Adleman (RSA) public key with the specified size in bits.

\*You can generate a PKCS#15 file with the NMC Security Wizard (available on [www.se.com](http://www.se.com)).

### Example 1: To generate a new ECDSA-521 public key, type

```
apc> ssl key -ecdsa 521
E000: Success
```

### Example 2: To import the public key from a .p15 file generated by the NMC Security Wizard CLI Utility, type

```
apc> ssl key -i nmc.p15
E000: Success
```

### Configure Certificate Signing Request (*csr*):

Option	Argument	Description
-s	<File Name>	Show the current CSR. If no file path is specified, the command checks the default location: ssl/nmc.csr.
-q	<File Name>	Create a CSR from an active configuration. If no file path is specified, the CSR is stored at the default location: ssl/nmc.csr
-CN	<Common Name>	Create a custom CSR. The Common Name is the fully qualified domain name (FQDN) of the Rack ATS. For example, its IP address or *.nmc.local.
Custom Certificate Signing Request (CSR) options. <b>NOTE:</b> The options below are only available for -CN		
-O	<organization>	The name of your organization.
-OU	<organization unit>	The division of your organization handling the certificate.
-C	<country>	The two-letter country code of where your organization is located.
-san	<Common Name   IP Address>	The Common Name or IP address of the Rack ATS.

**NOTE:** Created Certificate Signing Requests will be stored in the Rack ATS unit's ssl directory. See *dir*, page 56.

### Example 3: To create a quick CSR from the current configuration, type

```
apc> ssl csr -q
E000: Success
```

### Example 4: To create a minimal CSR, type

```
apc> ssl csr -CN 192.168.1.100 -C US
E000: Success
```

### Example 5: To create a custom Certificate Signing Request (CSR), type

```
apc> ssl csr -CN apcXXXXXX.nmc.local -C US -san *.nmc.local
-san 190.0.2.0
E000: Success
```

**Configure the Web UI's certificate (cert):**

Option	Argument	Description
-s	<File Name>	Display the specified certificate. <b>NOTE:</b> Executing this option without an argument will display the current certificate in use.
-f	<File Name>	Display the specified certificate's fingerprint. <b>NOTE:</b> Executing this option without an argument will display the current certificate's fingerprint.
-i	<File Name>	Import a certificate.
<b>NOTE:</b> The argument is optional for all three options. If no file path is specified, the command checks the default location: ssl/nmc.crt.		

**Example 6:** To show the active certificate, type

```
apc> ssl cert -s
E000: Success
```

Certificate

```
-----
Serial Number: XXXXxXXXXXXXXxXXXXx
Issuer: CN=., C=US
Validity:
    Not Before: Mon Oct 11 16:46:44 2021 UTC
    Not After : Sat Dec 15 23:59:59 2035 UTC
Subject: CN=., C=US
Subject Public Key Info:
    Public Key Algorithm: ECDSA (256 bit)
X:
    xx:xx:xx:xx:xx:xx:xx:xx:xx:xx:xx:xx:xx:xx:xx:xx:
    xx:xx:xx:xx:xx:xx:xx:xx:xx:xx:xx:xx:xx:xx:xx:xx:
Y:
    xx:xx:xx:xx:xx:xx:xx:xx:xx:xx:xx:xx:xx:xx:xx:xx:
    xx:xx:xx:xx:xx:xx:xx:xx:xx:xx:xx:xx:xx:xx:xx:xx:
Curve: P-256

Thumbprint: xxxxxxxxxxxxxxxxxxxxxxxxxxxxxxxxxxxxxxxxxxxx
Fingerprint:
xxxxxxxxxxxxxxxxxxxxxxxxxxxxxxxxxxxxxxxxxxxxxxxxxxxxxxxx
```

**Example 7:** To display nmc.crt located in the ssl directory, type

```
ssl cert -s ssl/nmc.crt
```

**Example 8:** To import another certificate (*other.crt*), type

```
apc> ssl cert -i other.crt
```

**Error Messages:** E000, E102

## system

**Access:** Super User, Administrator

**Description:** View and set the system name, the contact, the location. Configure system messages, view up time as well as the date and time, the logged-on user, and the high-level system status P, N, A. (See About the Main Screen, page 42 for more information about system status).

**Parameters:**

Option	Argument	Description
-n	<system name>	Define the device name, the name of the person responsible for the device, and the physical location of the device.
-c	<system contact>	
-l	<system location>	

		<p><b>NOTE:</b> If you define a value with more than one word, you must enclose the value in quotation marks. These values are also used by StruxureWare Data Center Expert, or EcoStruxure IT Expert and the Rack ATS unit's SNMP agent.</p>
-m	<system message>	Show a configurable custom message or banner on the logon page of the Web UI, CLI (Serial, Telnet, SSH), FTP or SCP.
-s	<enable   disable>	<p>Allow the host name to be synchronized with the system name so both fields automatically contain the same value.</p> <p>This is the same as using "dns -y".</p> <p><b>NOTE:</b> When enabling this feature, the system name identifier can no longer contain a space character (since it will be synchronized to the host name field).</p>

**Example 1:** To set the device location as Test Lab, type

```
apc> system -l "Test Lab"
E000: Success
```

**Example 2:** To set the system name as Don Adams, type

```
apc> system -n "Don Adams"
E000: Success
```

**Error Message:** E000, E102

## tacacs+

**Access:** Super User, Administrator, Network-Only User

**Description:** View the existing TACACS+ settings and configure basic authentication parameters for up to two TACACS+ servers.

Option	Argument	Description
-p1 -p2	<server IP>	The server name or IP address of the primary or secondary TACACS+ server.
-o1 -o2	<port>	The port number of the primary or secondary TACACS+ server.  <b>NOTE:</b> TACACS+ servers use port 49 by default to authenticate users. The NMC supports ports 1 to 65535.
-s1 -s2	<server secret>	The shared secret between the primary or secondary TACACS+ server and the NMC.
-t1 -t2	<server timeout>	The time in seconds that the NMC waits for a response from the primary or secondary TACACS+ server.
-d1 -d2		Delete the primary or secondary TACACS+ server configuration.
-r	<0 – 15>	Read-Only User privilege level.
-a	<0 – 15>	Administrator privilege level.

**Example 1:** To view the existing TACACS+ settings for the NMC, type:

```
tacacs+
```

**Example 2:** To configure a 10 second time out for a secondary TACACS+ server, type:

```
tacacs+ -t2 10
```

## tcpip

**Access:** Super User, Administrator

**Description:** View and manually configure IPV4 TCP/IP settings for the Rack ATS.

**Parameters:**

Option	Argument	Description
-s	enable   disable	Enable or disable TCP/IP v4.
-l	<IPv4 address>	Type the IP address of the Rack ATS, using the format xxx.xxx.xxx.xxx
-s	<subnet mask>	Type the subnet mask for the Rack ATS.
-g	<gateway>	Type the IP address of the default gateway. Do not use the loopback address (127.0.0.1) as the default gateway.
-d	<domain name>	Type the DNS name configured by the DNS server.
-h	<host name>	Type the host name that the Rack ATS will use.

**Example 1:** To view the network settings of the Rack ATS, type

```
apc> tcpip
E000: Success
IP Address:      192.168.1.50
MAC Address:     XX XX XX XX XX XX
Subnet Mask:     255.255.255.0
```

```
Gateway:          192.168.1.1
Domain Name:     example.com
Host Name:       HostName
```

**Example 2:** To manually configure an IP address of 192.168.1.49, type

```
apc> tcpip -i 192.168.1.49
E000: Success
Reboot required for change to take effect
```

**Error Message:** E000, E102

## tcpip6

**Access:** Super User, Administrator

**Description:** Enable IPv6. View and manually configure these network settings for the Rack ATS:

**Parameters:**

Option	Argument	Description
-s	enable   disable	Enable or disable IPv6.
-man	enable   disable	Enable manual addressing for the IPv6 address of the Rack ATS.
-auto	enable   disable	Enable the Rack ATS to automatically configure the IPv6 address
-i	<IPv6 address>	Set the IPv6 address of the Rack ATS
-g	<IPv6 gateway>	Set the IPv6 address of the default gateway
-d6	router   stateful   stateless   never	Set the DHCPv6 mode, with parameters of router controlled. <i>stateful</i> (for address and other information, they maintain their status), <i>stateless</i> (for information other than address, the status is not maintained), or <i>never</i> .

**Example 1:** To view the network settings of the Rack ATS, type `tcpip6` and press ENTER.

```
apc> tcpip6
E000: Success
```

```
IPv6:                enabled
Manual Settings:    disabled

IPv6 Address:       ::/64
MAC Address:        XX XX XX XX XX XX
Gateway:            ::
IPv6 Manual Address: disabled
IPv6 Autoconfiguration: enabled
DHCPv6 Mode:       router controlled
```

**Example 2:** To manually configure an IPv6 address of 2001:0:0:0:FFD3:0:57ab for the, type

```
tcpip -i 2001:0:0:0:0:FFD3:0:57ab
```

**Error Message:** E000, E102

## user

**Access:** Super User, Administrator

**Description:** Configure the user name, password, and inactivity timeout for each account type.

**NOTE:** You can't edit a user name; you must delete it and then create a new user.

**NOTE:** To change the Super User account settings remotely, you must enter the current password (`-cp`).

**Parameters:**

Option	Argument	Description
<code>-n</code>	<code>&lt;user&gt;</code>	Indicate the user.
<code>-cp</code>	<code>&lt;current password&gt;</code>	For a Super User, you must specify the current password. <b>NOTE:</b> The <code>-cp</code> option is only required when changing the Super User's settings remotely.
<code>-pw</code>	<code>&lt;user password&gt;</code>	Specify these options for a user. <b>NOTE:</b> The description must be enclosed in quotation marks.
<code>-pe</code>	<code>&lt;user permission&gt;</code>	
<code>-d</code>	<code>&lt;user description&gt;</code>	
<code>-e</code>	<code>enable   disable</code>	Enable or disable access for the particular user account.
<code>-te</code>	<code>enable   disable</code>	Enable or disable touch screen access.
<code>-tp</code>	<code>&lt;touch screen access pin&gt;</code>	This option is only available on certain devices.
<code>-tr</code>	<code>enable   disable</code>	Enable the touch screen remote authorization override. This option is only available on certain devices. If you enable this override, the Rack ATS will allow a local user to log on using the password for the Rack ATS that is stored locally on the Rack ATS.
<code>-st</code>	<code>&lt;session timeout&gt;</code>	Specify how long a session lasts when the keyboard is idle before the user is automatically logged off.
<code>-sr</code>	<code>enable   disable</code>	Bypass RADIUS by using the serial console (CLI) connection, also known as Serial Remote Authentication Override
<code>-el</code>	<code>enable   disable</code>	Indicate the Event Log color coding.
<code>-lf</code>	<code>tab   csv</code>	Indicate the format for exporting a log file.
<code>-ts</code>	<code>us   metric</code>	Indicate the temperature scale, Fahrenheit or Celsius.
<code>-df</code>	<code>&lt;mm/dd/yyyy   dd.mm.yyyy   mmm-dd-yy   dd-mmm-yy   yyyy-mm-dd&gt;</code>	Specify a date format.
<code>-lg</code>	<code>&lt;language code (e.g. enUs)&gt;</code>	Specify a user language. English is the only available language at this time.
<code>-del</code>	<code>&lt;user name&gt;</code>	Delete a user.
<code>-l</code>		Display the current user list.

**Example 1:** To change the log off time to 10 minutes for user "JMurphy", type `user -n "JMurphy" -st 10`

**Example 2:** To change the log off time to 10 minutes for the Super User "apc", type `user -n "apc" -cp <password> -st 10`

**Error Message:** E000, E102

## userauth

**Access:** Super User, Administrator, Network-Only User

**Description:** View or configure the user authentication method. Local authentication, as well as the LDAP, RADIUS, and TACACS+ protocols are supported.

Option	Argument	Description
-l	first   last   off	<p>Specify if and when the local user database is checked:</p> <p><b>first:</b> The local user database is always checked first. If the username is found, then the password is checked and the login either succeeds or is unsuccessful. If the username is not found, then remote authentication is used, if enabled.</p> <p><b>last:</b> The local user database is checked after attempting remote authentication, if there is an error contacting the remote authentication server. When remote authentication is off, it behaves the same as first.</p> <p><b>off:</b> The local user database is never checked.</p> <p><b>Note:</b> Setting this to off is not recommended as it can result in being permanently locked out of the NMC if the remote authentication server goes down or is misconfigured on the NMC. If off is used, it is strongly recommended to enable the Remote Authentication Override setting (session -a) and to set the Serial Remote Authentication Override option (user -sr) for the Super User or an Administrator.</p> <p><b>Note:</b> If both Local and Remote User Authentication settings are set to off, then Local User Authentication will automatically be set to first.</p>
-r	off   radius   tacacs+   ldap	<p>Specify which, if any, and remote authentication protocol is used:</p> <p><b>off:</b> Do not use remote user authentication and always perform local user authentication.</p> <p><b>radius:</b> Remote user authentication will use RADIUS.</p> <p><b>tacacs+:</b> Remote user authentication will use TACACS+.</p> <p><b>ldap:</b> Remote user authentication will use LDAP.</p>

**Example :** To configure local authentication first, followed by TACACS+ authentication, type:

```
userauth -l first -r tacacs+
```

## userdfit

**Access:** Super User, Administrator

**Description:** Complimentary function to “user” establishing default user preferences. There are two main features for the default user settings:

- Determine the default values to populate in each of the fields when the Super User or Administrator-level account creates a new user. These values can be changed before the settings are applied to the system.
- For remote users (user accounts not stored in the system that are remotely authenticated such as RADIUS) these are the values used for those that are not provided by the authenticating server. For example, if a RADIUS server does not provide the user with a temperature preference, the value defined in this section will be used.

**Parameters:**

Options	Argument	Description
-e	<enable   disable>	By default, user will be enabled or disabled upon creation.
-pe	<Administrator   Device   Read-Only   Network-Only>	Specify the user's permission level and account type.
-d	<user description>	Provide a user description. The description must be enclosed in quotation marks.
-st	<session timeout>minute(s)	Provide a default session timeout.
-bl	<bad login attempts>	Number of incorrect login attempts a user has before the system disables their account. Upon reaching this limit, a message is displayed informing the user the account has been locked. The Super User or an Administrator-level account is needed to re-enable the account to allow the user to log back in.  <b>NOTE:</b> A Super User account cannot be locked out, but can be manually disabled if necessary.
-el	<enable   disable> (Event Log Color Coding)	Enable or disable event log color coding.
-lf	<tab   csv> (Export Log Format)	Specify the log export format, tab or CSV.
-ts	<us   metrics> (Temperature Scale)	Specify the user's temperature scale. This setting is also used by the system when a user preference is not available (for example, email notifications).
-df	<mm/dd/yyyy   dd.mm.yyyy   mmm-dd-yy   dd-mmm-yy   yyyy-mm-dd> (Date Format)	Specify the user's preferred date format.
-lg	<language code (enUs, etc)>	User language. Only enUs is supported at this time.
-sp	<enable   disable>	Strong password requirements. When enabled: <ul style="list-style-type: none"> <li>The password must be 8–64 characters long.</li> <li>The password must contain at least one lowercase letter, one uppercase letter, one number, and one symbol ( ! " # \$ % &amp; ' ( ) * + , - . / : ; &lt; = &gt; ? @ [ \ ] ^ _ ` {   } ~ ).</li> </ul>
-pp	<interval in days>	Required password change interval.

**Example:** To set the default user's session timeout to 60 minutes, type

```
apc> userdfilt -st 60
E000: Success
```

**Error Message:** E000, E102

## web

**Access:** Super User, Administrator

**Description:** Enable access to the Web UI using HTTP or HTTPS.

For additional security, you can change the port setting for HTTP and HTTPS to any unused port from 5000 to 32768. Users must then use a colon (:) in the address field of the browser to specify the port number. For example, for a port number of 5000 and an IP address of 152.214.12.114, type:

```
http://152.214.12.114:5000
```

**Parameters:**

Option	Argument	Definition
-h	enable   disable	Enable or disable access to the user interface for HTTP. HTTP is disabled by default.
-s	enable   disable	Enable or disable access to the user interface for HTTPS. HTTPS is enabled by default. When HTTPS is enabled, data is encrypted during transmission and authenticated by digital certificate.
-mp	<minimum protocol>	Specify the minimum protocol used by the web interface: SSL v3.0, TLS v1.1, or TLS v1.2.

-ph	<http port #>	Specify the TCP/IP port used by HTTP to communicate with the Rack ATS (80 by default). The other available range is 5000–32768.
-ps	<https port #>	Specify the TCP/IP port used by HTTPS to communicate with the Rack ATS (443 by default). The other available range is 5000–32768.
-lsp	enable   disable	Enable or disable access to the Limited Status page in the Web UI.
-lsd	enable   disable	Enable or disable the Limited Status page being used as the default page when accessing the device's IP or hostname in a web browser.
-cs	<0   1   2   3   4>	Select the level of security of TLS v1.2 cipher suites between 0 - 4, where 4 is the highest level of security, and 0 is the lowest level of security. The default value is 4.  <b>NOTE:</b> The -cs option is only applied when -mp is set to TLS v1.2.  When a value between 0 - 4 is entered, the CLI responds with a list of the currently allowed SSL cipher suites.
-hs	enable   disable	Enable/ disable the HTTP Strict Transport Security Header (HSTS) response header.

**Example 1:** To prevent all access to the Web UI, type

```
apc> web -h disable -s disable
```

**Example 2:** To define the TCP/IP port used by HTTP, type

```
apc> web -ph 80
E000: Success
```

**Error Message:** E000, E102

## whoami

**Access:** Super User, Administrator, Device User, Read-Only User, Network-Only User

**Description:** Provides login information on the current user.

**Parameters:** None

**Example:**

```
apc> whoami
E000: Success
admin
```

**Error Message:** E000, E102

## wifi

Reserved for future use.

## xferINI

**Access:** Super User, Administrator

**Description:** Use XMODEM to upload an INI file while you are accessing the Command Line Interface through a serial connection. After the upload completes:

- If there are any system or network changes, the Command Line Interface restarts and you must log on again.
- If you selected a baud rate for the file transfer that is not the same as the default baud rate for the NMC, you must reset the baud rate to the default to reestablish communication with the NMC.

**Parameters:** None

**Example:**

```
apc> xferINI
Enter 'YES' or 'Y' to continue or <ENTER> to cancel: <user
enters 'YES' or 'Y'>
---- File Transfer Baud Rate-----
      1- 2400
      2- 9600
      3- 19200
      4- 38400
> <user enters baudrate selection>
Transferring at current baud rate (9600), press <ENTER>...
<user presses <ENTER>>
Start XMODEM-CRC Transfer Now!
CC
<user starts sending INI>
150 bytes have successfully been transmitted.

apc>
```

**Error Message:** None

## xferStatus

**Access:** Super User, Administrator

**Description:** View the result of the last file transfer.

**Parameters:** None

**Example:**

```
apc> xferStatus
E000: Success
```

Result of last file transfer: Successful

See Last Transfer Result Codes, page 30 for descriptions of the transfer result codes.

**Error Message:** E000

---

# Device Command Descriptions

## Network Port Sharing Commands

The CLI allows commands to be sent to guest Rack ATS units. The user may specify the Display ID of the Rack ATS to be commanded, followed by a colon, before the first argument (or as the first argument, if the command does not normally have arguments). If a Display ID is optional, omitting it will simply command the host Rack ATS.

For example: `<command> [<id#>:]<arg1> <arg2>`

This will send `<command> <arg1> <arg2>` to the Rack ATS with the Display ID specified by `[<id#>:]`. The Display ID is followed by a colon (:), which is followed by `arg1` with no spaces. Spaces are used to delimit arguments.

## aboutATS

**Access:** Super User, Administrator, Device User, Read Only User

**Description:** Display ATS controller information.

**Parameters:** None

**Example:**

```
apc> aboutATS
E000: Success
Model:                AP4450A
Firmware Rev:         0.0.2.5
Firmware Date:        09/23/23
Hardware Rev:         R01
Manufacture Date:     02/04/2023
Serial Number:        XXXXXXXXXXXX
```

**Error Messages:** E000, E102

## atsMeasure

**Access:** Super User, Administrator, Device User, Read Only User

**Description:** Read source power measurements and ATS power measurements.

**Parameters:** None.

**Example:**

```
apc> atsMeasure
E000: Success
Source A Freq:           60 Hz
Source A Voltage:       121 V
Source B Freq:           60 Hz
Source B Voltage:       121 V
Total Output Power:     1.00 kVA
Source A 24V Power Supply: 24 V
Source B 24V Power Supply: 24 V
Source A Boost Voltage: 40 V
Source B Boost Voltage: 40 V
3.3 V Power Supply:     3.3 V
```

**Error Messages:** E000, E102

## atsStatus

**Access:** Super User, Administrator, Device User, Read Only User

**Description:** Read Rack ATS status information.

**Parameters:** None.

**Example:**

```
apc> atsStatus
E000: Success
Communication Status:   OK
Selected Source:        Source B
Preferred Source:       Source B
Switch Status:          OK
Front Panel:            Unlocked
Source A:                OK
Source B:                Selected
Phase Synchronization: Sync
Source A 24V Power Supply: OK
Source B 24V Power Supply: OK
Source A 24V Boost Voltage: OK
Source B 24V Boost Voltage: OK
3.3V Power Supply:     OK
```

**Error Messages:** E000, E102

## bkLowLoad

**Access:** Super User, Administrator, Device User

**Description:** Set or view the bank low-load threshold current in amps. Only single phase SKUs with two or more circuit breakers support this command.

**Parameters:**

Argument	Description
<id#>	The id of a unit in the NPS group (can be 1–32 depending on the group size)
<all   bank#>	all = all bank numbers  bank# = a single number, a range of numbers separated with a dash, or a comma-separated list of single bank number and/or number ranges
<current>	The new bank threshold (Amps)

**NOTE:** The maximum bank number is 2. If the Rack ATS has two circuit breakers, a total bank threshold is provided.

**Example 1:** View low-load thresholds for all banks.

```
apc> bkLowLoad all
E000: Success
total:    0 A
1:        0 A
2:        0 A
```

**Example 2:** View and set the low-load threshold for bank 1.

```
apc> bkLowLoad 1
E000: Success
1: 0 A

apc> bkLowLoad 1 1
E000: Success
```

**Example 2:** View and set the low-load thresholds for banks 1–2.

```
apc> bkLowLoad 1-2
E000: Success
total:    2 A
1:        1 A
2:        1 A

apc> bkLowLoad 1-2 1
E000: Success
```

**Error Messages:** E000, E102

## bkNearOver

**Access:** Super User, Administrator, Device User

**Description:** Set or view the bank near-overload threshold current in amps. Only single phase models with two or more circuit breakers support this command. You can specify all banks, a single bank, a range, or a comma-separated list of single banks and/or ranges.

**Parameters:**

Argument	Description
<id#>:	The id of a unit in the NPS group (can be 1–32 depending on the group size)
<all   bank#>	all = all bank numbers  bank#: = a single number, a range of numbers separated with a dash, or a comma-separated list of single bank number and/or number ranges
<current>	The new bank threshold (Amps)

**NOTE:** The maximum bank number is 2. If the Rack ATS has two circuit breakers, a total bank threshold is provided.

**Example 1:** View and set the near-overload threshold for all banks.

```
apc> bkNearOver all
E000: Success
total:    10 A
1:        10 A
2:        10 A

apc> bkNearOver all 10
E000: Success
E000: Success
E000: Success
```

**Example 2:** View and set the near-overload threshold for bank 1.

```
apc> bkNearOver 1
E000: Success
1: 10 A

apc> bkNearOver 1 12
E000: Success

apc> bkNearOver all
E000: Success
total:    12 A
1:        12 A
2:        10 A
```

**Example 3:** View the near-overload threshold setting for banks 1 and 2 on guest unit 3.

```
apc> bkNearOver 3:1-2
E000: Success
1: 16 A
2: 16 A
```

**Error Messages:** E000, E102

## bkOverLoad

**Access:** Super User, Administrator, Device User

**Description:** Set or view the bank overload threshold current in amps. Only single phase SKUs with two or more circuit breakers support this command.

**Parameters:**

Argument	Description
<id#>:	The id of a unit in the NPS group (can be 1–32 depending on the group size)
<all   bank#>	all = all bank numbers  bank#: = a single number, a range of numbers separated with a dash, or a comma-separated list of single bank number and/or number ranges
<current>	The new bank threshold (Amps)

**NOTE:** The maximum bank number is 2. If the Rack ATS has two circuit breakers, a total bank threshold is provided.

**Example 1:** View bank overload thresholds for all banks.

```
apc> bkOverLoad all
E000: Success
total:    24 A
1:        14 A
2:        14 A
```

**Example 2:** View the overload threshold for bank 1.

```
apc> bkOverLoad 1
E000: Success
1: 14 A
```

**Example 3:** Set the overload threshold for banks 1 and 2.

```
apc> bkOverLoad 1-2 16
E000: Success

apc> bkOverLoad all
E000: Success
total:    32 A
1:        16 A
2:        16 A
```

**Error Messages:** E000, E102

## bkPeakLoad

**Access:** Super User, Administrator, Device User

**Description:** Display the peak load measurement from a bank(s). Only single phase SKUs with two or more circuit breakers support this command.

**Parameters:**

Argument	Description
<id#>:	The id of a unit in the NPS group (can be 1–32 depending on the group size)
<all   bank#>	all = all bank numbers  bank#: = a single number, a range of numbers separated with a dash, or a comma-separated list of single bank number and/or number ranges
<current>	The new bank threshold (Amps)

**NOTE:** The maximum bank number is 2. If the Rack ATS has two circuit breakers, a total bank threshold is provided.

**Example:**

```
apc> bkPeakLoad all
E000: Success
total:    11.0 A
1:        5.0 A
2:        5.0 A

apc> bkPeakLoad 1
E000: Success
1: 5.0 A

apc> bkPeakLoad 1-2
E000: Success
1: 5.0 A
2: 6.0 A
```

**Error Messages:** E000, E102

## bkReading

**Access:** Super User, Administrator, Device User, Read Only

**Description:** View the current reading (measurement) in amps for a bank. Only single phase models with two or more circuit breakers support this command.

**Parameters:**

Argument	Description
<id#>:	The id of a unit in the NPS group (can be 1–32 depending on the group size)
<all   bank#>	all = all bank numbers  bank#: = a single number, a range of numbers separated with a dash, or a comma-separated list of single bank number and/or number ranges
<current>	The new bank threshold (Amps)

**NOTE:** The maximum bank number is 2. If the Rack ATS has two circuit breakers, a total bank threshold is provided.

**Example :**

```
apc> bkReading 1
E000: Success
1: 6.3 A

apc> bkReading all
E000: Success
total:    11.4 A
1:        6.3 A
2:        5.1 A

apc> bkReading 1-2
E000: Success
1: 6.3 A
2: 5.1 A
```

**Error Messages:** E000, E102

## dispID

**Access:** Super User, Administrator

**Description:** Set or read the Display ID.

**Parameters:**

Argument	Description
<id#>:	The id of a unit in the NPS group (can be 1–32 depending on the group size)
<value>	The id that is being assigned to a unit (can be 1–32)

**Example :**

```
apc> dispID
E000: Success
ATS ID: 3*
```

```
apc> dispID 2
E000: Success
```

```
apc> dispID 2:4
E000: Success
```

**Error Messages:** E000, E102

## eventCounts

**Access:** Super User, Administrator, Device User

**Description:** Display or clear the event counts reported from the Rack ATS controller.

**Parameters:**

Argument	Description
<id#>:	The id of a unit in the NPS group (can be 1–32 depending on the group size)
<0>	Set all event counts to 0.

**Example:**

```
apc> eventcounts
E000: Success
Event Counts
-----
Redundancy Loss:           1
Source Switch:             0
Source Preference Change:  0
Spike/Dropout:             0
Surge/Droop:               0
Frequency out of Range:    0
```

**Error Messages:** E000, E100, E102

## freqDeviat

**Access:** Super User, Administrator, Device User

**Description:** Read or set the range of acceptable frequency fluctuation (Hz).

**Parameters:**

Argument	Description
<id#>:	The id of a unit in the NPS group (can be 1–32 depending on the group size)
<3   5   10>	The new range of acceptable frequency deviation: 3, 5, or 10 Hz above or below the nominal frequency.

**NOTE:** If the frequency (see `atsMeasure`, page 91) is at 50 Hz and `vSensitivity` (see `vSensitivity`, page 121) is set to High, `freqDeviat` should be 3 or 5.

**Example:**

```
apc> freqDeviat
E000: Success
Frequency Deviation:          3 Hz
```

**Error Messages:** E000, E100, E102

## frontPanel

**Access:** Super User, Administrator, Device User

**Description:** Set or view control for the source button on the front panel.

**Parameters:**

Argument	Description
<id#>:	The id of a unit in the NPS group (can be 1–32 depending on the group size)
<locked   unlocked>	Lock or unlock the front panel for use.

**Example:**

```
apc> frontPanel
E000: Success
Front Panel: unlocked

apc> frontPanel locked
E000: Success
```

**Error Messages:** E000, E100, E102

## Humidity Sensor Note:

You must connect an optional APC Temperature/Humidity Sensor (AP9335TH) to your Rack ATS in order to use the Humidity related commands.

## humAlGen

**Access:** Super User, Administrator, Device User

**Description:** Sets and reads whether humidity alarms are enabled or disabled.

**Parameters:**

Argument	Description
<id#>:	The id of a unit in the NPS group (can be 1–32 depending on the group size).
<enable   disable>	enable = enable humidity alarms. disable = disable humidity alarms.

**Example:**

```
apc> humAlGen enable
E000: Success
```

```
apc> humAlGen disable
E000: Success
```

**Error Message:** E000, E102

## humHyst

**Access:** Super User, Administrator, Device User

**Description:** Sets and reads the humidity threshold hysteresis value.

**Parameters:**

Argument	Description
<id#>:	The id of a unit in the NPS group (can be 1–32 depending on the group size)
<value>	new threshold hysteresis value (% RH)

**Example:**

```
apc> humHyst
E000: Success
6 %RH
```

```
apc> humHyst 5
E000: Success
```

**Error Message:** E000, E102

## humLow

**Access:** Super User, Administrator, Device User

**Description:** Set or view the low humidity threshold as a percent of the relative humidity.

**Parameters:**

Argument	Description
<id#>:	The id of a unit in the NPS group (can be 1–32 depending on the group size)
<humidity>	New low humidity threshold

**Example 1:** To view the low humidity threshold, type:

```
apc> humLow
E000: Success
10 %RH
```

**Example 2:** To set the low humidity threshold, type:

```
apc> humLow 12
E000: Success
```

**Example 3:** To view the low humidity threshold on guest Rack ATS 3, type:

```
apc> humLow 3:
E000: Success
10 %RH
```

**Error Message:** E000, E102

## humMin

**Access:** Super User, Administrator, Device User

**Description:** Set or view the minimum humidity threshold as a percent of the relative humidity.

**Parameters:**

Argument	Description
<id#>:	The id of a unit in the NPS group (can be 1–32 depending on the group size)
<humidity>	New minimum humidity threshold

**Example 1:** To view the minimum humidity threshold, type:

```
apc> humMin
E000: Success
6 %RH
```

**Example 2:** To set the minimum humidity threshold, type:

```
apc> humMin 8
E000: Success
```

**Example 3:** To view the humidity value on guest Rack ATS 2, type:

```
apc> humReading 2:
E000: Success
48 %RH
```

**Error Message:** E000, E102

## humReading

**Access:** Super User, Administrator, Device User, Read Only

**Description:** View the humidity value from the sensor.

**Parameters:**

Argument	Description
<id#>:	The id of a unit in the NPS group (can be 1–32 depending on the group size)

**Example 1:** To view the humidity value, type:

```
apc> humReading
E000: Success
25 %RH
```

**Example 2:** To view the humidity value on guest Rack ATS 2, type:

```
apc> humReading 2:
E000: Success
48 %RH
```

**Error Message:** E000, E102, E201

## humStatus

**Access:** Super User, Administrator, Device User, Read Only

**Description:** Displays the status of the sensor. Responses: Not Connected, Min Threshold Violation, Low Threshold Violation, Normal.

**Parameters:**

Argument	Description
<id#>:	The id of a unit in the NPS group (can be 1–32 depending on the group size)

**Example:** To view the status of the humidity sensor, type:

```
apc> humStatus 1
Not Connected
```

**Error Message:** None

## Icd

**Access:** Super User, Administrator, Device User

**Description:** Set or read the LCD display status.

**Parameters:**

Argument	Description
<id#>:	The id of a unit in the NPS group (can be 1–32 depending on the group size)
<on   off>	Turn the LCD on or off.

**Example:**

```
apc> lcd
E000: Success
LCD Status: On
```

```
apc> lcd off
E000: Success
```

**Error Messages:** E000, E100, E102

## IcdBlink

**Access:** Super User, Administrator

**Description:** Specify a number of minutes to blink the display. This command can be canceled by pressing a button on the LCD.

**Parameters:**

Argument	Description
<id#>:	The id of a unit in the NPS group (can be 1–32 depending on the group size).
<time>	number of minutes to blink the display. Valid range is [1-10].

**Example:**

```
apc> lcdBlink 2
E000: Success
```

**Error Messages:** E000, E102

## lineVRMS

**Access:** Super User, Administrator

**Description:** Read or set the nominal source line voltage (V). Acceptable values depend on Rack ATS model.

**Parameters:**

Argument	Description
<id#>:	The id of a unit in the NPS group (can be 1–32 depending on the group size)
<voltage>	Set the nominal source line voltage (V).

Model	Acceptable voltages
AP4421A, AP4422A, AP4423A, AP4424A	230
AP4430A, AP4432A	200 or 208
AP4431A, AP4433A, AP4434A	208
AP4450A	100 or 120
AP4452A, AP4453A	120
AP4452AJ	100

**Example:**

```
apc> lineVRMS
E000: Success
Nominal Line Voltage: 120

apc> lineVRMS 124
E000: Success
```

**Error Messages:** E000, E100, E102

## logToFlash

**Access:** Super User, Administrator

**Description:** Export the log files to a USB flash drive. The file will be a compressed file. It will contain event.txt, config.ini, debug.txt, data.txt. If an exception occurs, it will also contain dump.txt.

**Parameters:** [<filename>] = the appendix to the debug file tar name. If no name is entered, the serial number of the device will be used as the name for the file.

**Example 1:**

```
apc>logToFlash 01292018
Creating report file: /debug_01292018.tar
Press <ESC> to abort
0% completed...
Exporting logs... please do not remove USB flash
12% completed...Exporting logs... please do not remove USB flash...
Exporting logs... please do not remove USB
flash 60% completed...
Logs export completed. You may remove USB flash now
```

**Example 2:**

```
apc>logToFlash
Creating report file:
/debug_ZA1234567890.tar Press <ESC> to abort
0% completed...Exporting logs... please do not remove USB flash
12% completed...Exporting logs... please do not remove USB flash...
Exporting logs... please do not remove USB flash
60% completed...Logs export completed. You may remove USB flash now
```

**Error Messages:** E000, E102

## modbus

**Access:** Super User, Administrator, Device User

**Description:** View and configure the options for Modbus TCP. The Modbus TCP allows a Building Management System (BMS) to monitor the Rack ATS device.

**Parameters:**

Option	Argument	Description
-tE	<enable   disable>	Enable or disable Modbus TCP.
-tP		View the Modbus TCP port number. (You can set the Modbus TCP port number in the Web UI.
-tTO	<0 - 64800>	Specify the Modbus TCP communication timeout in seconds, where 0 indicates that the connection never times out.
-ka	<enable   disable>	Modbus TCP keep-alive. Sends data packet to the server every two hours and 75 seconds if there is no other communication. Prevents communication timeout when the communication timeout is set to 7,275 seconds or more.
-rDef		Reset the Modbus configuration to defaults.

**Example 1:** To view modbus settings, type

```
apc> modbus
E002: Success

Slave Address = 0x1
Status = DISABLED
TCP Status = DISABLED
TCP Port Number = 502
TCP Communication Timeout = 5 secs
Keep-alive = ENABLED
```

**Example 2:** To enable modbus TCP, type:

```
apc> modbus -tE enable
E002: Success
Reboot required for change to take effect.
```

**Example 3:** To enable modbus TCP, type:

```
apc> modbus -tE disable
E002: Success
Reboot required for change to take effect.
```

**Error Messages:** E000, E002, E101, E102

## phLowLoad

**NOTE:** Only units without circuit breakers are supported by this command.

**Access:** Super User, Administrator, Device User

**Description:** Set or view the phase low-load threshold in Amps.

**Parameters:**

Argument	Description
<id#>:	The id of a unit in the NPS group (can be 1–32 depending on the group size)
<current>	New low-load threshold (Amps)

**Example:**

```
apc> phLowLoad
E000: Success
0 A
```

```
apc> phLowLoad 3
E000: Success
```

**Error Messages:** E000, E102

## phNearOver

**NOTE:** Only units without circuit breakers are supported by this command.

**Access:** Super User, Administrator, Device User

**Description:** Set or view the phase near-overload threshold in Amps.

**Parameters:**

Argument	Description
<id#>:	The id of a unit in the NPS group (can be 1–32 depending on the group size)
<current>	New near-overload threshold (Amps)

**Example:**

```
apc> phNearOver
E000: Success
8 A
```

```
apc> phNearOver 9
E000: Success
```

**Error Messages:** E000, E102

## phOverLoad

**NOTE:** Only units without circuit breakers are supported by this command.

**Access:** Super User, Administrator, Device User

**Description:** Set or view the phase overload threshold in amps.

**Parameters:**

Argument	Description
<id#>:	The id of a unit in the NPS group (can be 1–32 depending on the group size)
<current>	New overload threshold (Amps)

**Example:** To view the overload threshold, enter

```
apc> phOverLoad
E000: Success
10 A
```

To set the overload threshold for all phases to 10 A, enter

```
apc> phOverLoad
E000: Success
10 A
```

**Error Messages:** E000, E102

## phPeakLoad

**NOTE:** Only units without circuit breakers are supported by this command.

**Access:** Super User, Administrator, Device User, Read Only User

**Description:** View the phase peak load.

**Parameters:**

Argument	Description
<id#>:	The id of a unit in the NPS group (can be 1–32 depending on the group size)

**Example:**

```
apc> phPeakLoad
E000: Success
4.0 A
```

**Error Messages:** E000, E102

## phReading

**NOTE:** Only units without circuit breakers are supported by this command.

**Access:** Super User, Administrator, Device User

**Description:** View the phase load in Amps.

**Parameters:**

Argument	Description
<id#>:	The id of a unit in the NPS group (can be 1–32 depending on the group size)

**Example:**

```
apc> phReading
E000: Success
4.0 A
```

**Error Messages:** E000, E102

## prodInfo

**Access:** Super User, Administrator, Device User, Read Only

**Description:** View information about the Rack ATS.

**Parameters:**

Argument	Description
<id#>:	The id of a unit in the NPS group (can be 1–32 depending on the group size)

**Example:**

```
apc> prodInfo 2:
E000: Success
AOS:                               1.0.0.3
APP:                               0.0.2.5
Model:                             AP4452A
Name:                              apcRack_01
Location:                          Data Center Row 3
Contact:                           Don Adams
Outlets:                            10
Rated Load:                        16 A
Phases:                             1
Uptime:                            15 Days 1 Hours 8 Minutes
Network Link:                      Link Active
NPS Type:                          Host
NPS Status:                        Active
```

**Error Messages:** E000, E102

## sensorName

**Access:** Super User, Administrator, Device User

**Description:** Set or view the name assigned to the Rack ATS Universal I/O port (the connection point for the Temp/Humidity sensor).

**Parameters:**

Argument	Description
<id#>:	The id of a unit in the NPS group (can be 1–32 depending on the group size)
<newname>	The new name for the Universal I/O port

**Example 1:** To set the name for the port to “Sensor1,” type:

```
apc> sensorName Sensor1
E000: Success
```

**Example 2:** To then view the name for the sensor port, type:

```
apc> sensorName
E000: Success
Sensor1
```

**Example 3:** To set the name for the sensor port on guest Rack ATS 2 to “Sensor1,” type:

```
apc> sensorName 2:Sensor1
E000: Success
```

**Error Message:** E000, E102

## sourceAName

**Access:** Super User, Administrator, Device User

**Description:** Set or view the name assigned to power source A.

**Parameters:**

Argument	Description
<id#>:	The id of a unit in the NPS group (can be 1–32 depending on the group size)
<sourceAName>	Name for source A

**Example:**

```
apc> sourceAName
E000: Success
Wall Box Phase L1

apc> sourceAName "Wall Box N2 Phase L2"
E000: Success
```

**Error Messages:** E000, E102

## sourceBName

**Access:** Super User, Administrator, Device User

**Description:** Set or view the name of power Source B.

**Parameters:**

Argument	Description
<id#>:	The id of a unit in the NPS group (can be 1–32 depending on the group size)
<sourceBName>	Name for source B

**Example:**

```
apc> sourceBName
E000: Success
Wall Box Phase L2

apc> sourceBName "Wall Box N2 Phase L3"
E000: Success
```

**Error Messages:** E000, E102

## sourcePref

**Access:** Super User, Administrator, Device User

**Description:** Set or view the desired source preference.

**Parameters:**

Argument	Description
<id#>:	The id of a unit in the NPS group (can be 1–32 depending on the group size)
<A   B   None>	A = Prefer Source A. B = Prefer Source B. None = No preference

**Example:**

```
apc> sourcePref
E000: Success
Preferred Source: Source A

apc> sourcePref B
E000: Success
```

**Error Messages:** E000, E102

## Temperature Sensor Note:

You must connect an optional APC Temperature/Humidity Sensor (AP9335T/ AP9335TH) to your Rack ATS in order to use the Temperature related commands.

## tempAlGen

**Access:** Super User, Administrator, Device User

**Description:** Sets or reads whether temperature alarms are enabled or disabled.

**Parameters:**

Argument	Description
<id#>:	The id of a unit in the NPS group (can be 1–32 depending on the group size)
<enable   disable>	enable = enable temperature alarms. disable = disable temperature alarms.

**Example:**

```
apc> tempAlGen enable
E000: Success
```

```
apc> tempAlGen disable
E000: Success
```

**Error Message:** E000, E102

## tempHigh

**Access:** Super User, Administrator, Device User

**Description:** Set or view the high-temperature threshold in either Fahrenheit or Celsius.

**Parameters:**

Argument	Description
<id#>	The id of a unit in the NPS group (can be 1–32 depending on the group size)
<F   C>	Fahrenheit (F) or Celsius (C)
<temperature>	New high temperature threshold

**Example 1:** To set the high-temperature threshold to 70° Fahrenheit, type:

```
apc> tempHigh F 70
E000: Success
```

**Example 2:** To view the high-temperature threshold in Celsius, type:

```
apc> tempHigh C
E000: Success
21 C
```

**Example 3:** To view the high-temperature threshold of guest Rack ATS 2 in Fahrenheit, type:

```
apc> tempHigh 2:F
E000: Success
70 F
```

**Error Message:** E000, E102

## tempHyst

**Access:** Super User, Administrator, Device User

**Description:** Set and displays the temperature threshold hysteresis.

**Parameters:**

Argument	Description
<id#>:	The id of a unit in the NPS group (can be 1–32 depending on the group size)
<F   C>	Fahrenheit (F) or Celsius (C)
<temperature>	New temperature hysteresis value

**Example:**

```
apc> tempHyst F 6
E000: Success
```

```
apc> tempHyst C
E000: Success
3 C
```

**Error Message:** E000, E102

## tempMax

**Access:** Super User, Administrator, Device User

**Description:** Set or view the max-temperature threshold in either Fahrenheit or Celsius. The id# may be from 1 to 32 depending on the group size.

**Parameters:**

Argument	Description
<id#>:	The id of a unit in the NPS group (can be 1–32 depending on the group size)
< F   C >	Fahrenheit (F) or Celsius (C)
<temperature>	New max temperature threshold

**Example 1:** To set the max-temperature threshold to 80° Fahrenheit, type:

```
apc> tempMax F 80
E000: Success
```

**Example 2:** To view the max-temperature threshold in Celsius, type:

```
apc> tempMax C
E000: Success
27 C
```

**Example 3:** To view the max-temperature threshold of guest Rack PDU 3 in Fahrenheit, type:

```
apc> tempMax 3:F
E000: Success
95 F
```

**Error Message:** E000, E102

## tempPeak

**Access:** Super User, Administrator, Device User

**Description:** Display the peak temperature reading of the sensor.

**Parameters:**

Argument	Description
<id#>:	The id of a unit in the NPS group (can be 1–32 depending on the group size)
<F   C>	Fahrenheit (F) or Celsius (C)

**Example:**

```
apc> tempPeak F
E000: Success
77.5 F
```

**Error Message:** E000, E102

## tempReading

**Access:** Super User, Administrator, Device User, Read Only

**Description:** View the temperature value in either Fahrenheit or Celsius from the sensor.

**Parameters:**

Argument	Description
<id#>:	The id of a unit in the NPS group (can be 1–32 depending on the group size)
< F   C >	Fahrenheit (F) or Celsius (C)

**Example 1:** To view the temperature value in Fahrenheit, type:

```
apc> tempReading F
E000: Success
51.1 F
```

**Example 2:** To view the temperature value of guest Rack ATS 3 in Celsius, type:

```
apc> tempReading 3:C
E000: Success
23.5 C
```

**Error Message:** E000, E102, E201

## vMediumLimit

**Access:** Super User, Administrator, Device User

**Description:** Set or view the voltage range to use when the Voltage Transfer Range is set to Medium. This value must be greater than the Narrow Transfer Limit and less than the Wide Limit (V).

**Parameters:**

Argument	Description
<id#>:	The id of a unit in the NPS group (can be 1–32 depending on the group size)
[<limit>]	Medium voltage transfer range. Acceptable values depend on the Rack ATS model.

Model	Acceptable range values
AP4421A, AP4422A, AP4423A, AP4424A	16–25
AP4430A, AP4432A, AP4433A, AP4434A	15–30
AP4452AJ	10–15
AP4450A, AP4452A, AP4453A	10–23

**Example:**

```

apc> vMediumLmt
E000: Success
Voltage Medium Limit: 12 V

apc> vMediumLmt 14
E000: Success

```

**Error Messages:** E000, E100, E102

## vNarrowLmt

**Access:** Super User, Administrator, Device User

**Description:** Set or view the voltage range to use when the Voltage Transfer Range is set to Narrow. This value must be less than the Medium Limit.

**Parameters:**

Argument	Description
<id#>	The id of a unit in the NPS group (can be 1–32 depending on the group size)
[<limit>]	Narrow voltage transfer range. Acceptable values depend on the Rack ATS model.

Model	Acceptable range values
AP4421A, AP4422A, AP4423A, AP4424A	16–25
AP4430A, AP4432A, AP4433A, AP4434	15–30
AP4452JA	10–15
AP4450A, AP4452A, AP4453	10–23

**Example:**

```
apc> vNarrowLmt
E000: Success
Voltage Narrow Limit: 15 V
```

**Error Messages:** E000, E100, E102

## vSensitvty

**Access:** Super User, Administrator, Device User

**Description:** Set or view the sensitivity.

**Parameters:**

Argument	Description
<id#>:	The id of a unit in the NPS group (can be 1–32 depending on the group size)
<High   Low>	Set the sensitivity of the Rack ATS.  High = The Rack ATS will switch power sources after 2 ms when there is a disturbance in the power supply.  Low = The Rack ATS will switch sources after 4 ms when there is a disturbance in the power supply.

**NOTE:** If the **Frequency** is at 50 Hz (see **atsMeasure**, page 91) and **FreqDeviat** (see **freqDeviat**, page 98) is set to 10, **vSensitvty** should be set to **Low**.

**Example:**

```
apc> vSensitvty
E000: Success
Voltage Sensitivity: Low

apc> vSensitvty High
E000: Success
```

**Error Messages:** E000, E100, E102

## vWideLmt

**Access:** Super User, Administrator, Device User

**Description:** Set or view the voltage range to use when Voltage Transfer Range is set to Wide. This value must be greater than the Medium Limit.

**Parameters:**

Argument	Description
<id#>:	The id of a unit in the NPS group (can be 1–32 depending on the group size)
[<limit>]	Wide voltage transfer range. Acceptable values depend on the Rack ATS model.

Model	Acceptable range values
AP4421A, AP4422A, AP4423A, AP4424A	16–25
AP4430A, AP4432A, AP4433A, AP4434A	15–30
AP4452AJ	10–15
AP4450A, AP4452A, AP4453A	10–23

**Example:**

```
apc> vWideLmt
E000: Success
Voltage Wide Limit: 20

apc> vWideLmt 24
E000: Success
```

**Error Messages:** E000, E102

## vXferRange

**Access:** Super User, Administrator, Device User

**Description:** Set or view the Voltage Transfer Range. If the voltage of an Rack ATS exceeds the Transfer Range, it generates an alarm.

**Parameters:** Voltage transfer range.

Argument	Description
<id#>:	The id of a unit in the NPS group (can be 1–32 depending on the group size)
<Wide   Medium   Narrow>	Wide: corresponds to configured values for vWideLmt Medium: corresponds to configured values for vMediumLmt Narrow: corresponds to configured values for vNarrowLmt

**Example:**

```
apc> vXferRange
E000: Success
Voltage Transfer Range: Medium

apc> vXferRange Wide
E000: Success
```

**Error Messages:** E000, E102

# Web User Interface

You can use the latest version of Microsoft Internet Explorer® (IE) or Edge®, Google Chrome®, Apple Safari®, or Mozilla Firefox® to access the Rack ATS through its Web UI. Other commonly available browsers and versions may work but have not been fully tested.

To access the Web UI on any operating system, use the latest releases of Mozilla Firefox®, or Google Chrome®. Other commonly available browsers also may work but have not been fully tested by Schneider Electric.

The Rack ATS cannot work with a proxy server. Before accessing the Web UI of the Rack ATS, do one of the following:

- Configure the browser to disable the use of a proxy server for your Rack ATS.
- Configure the proxy server so that it does not proxy the specific IP address of your Rack ATS.

## Log on to the Web UI

To access the Web UI and configure the security settings of your Rack ATS on the network:

1. Type the DNS name or IP address of the Rack ATS in the Web browser's URL address field and press ENTER.

**NOTE:** If you are using HTTPS (SSL/TLS) as your access protocol, your login credentials are compared with information in a server certificate. If the certificate was created with the Security Wizard, and an IP address was specified as the common name in the certificate, you must use an IP address to log on to the Rack ATS. If a DNS name was specified as the common name on the certificate, you must use a DNS name to log on.

You may receive a message that the Web page is not secure. This is normal, and you can continue to the Web UI. The warning is generated because your Web browser does not recognize the default certificate used for encryption over HTTPS. However, information transmitted over HTTPS is still encrypted. See the *Security Handbook* on [www.se.com](http://www.se.com) for more details on HTTPS and instructions to resolve the warning.

2. Enter the user name and password. (By default, both values are **apc** for the Super User and Administrator. The Super User, or an Administrator created by the Super User, should define the user name, password, and account characteristics for other users).

## URL address formats

Type the DNS name or IP address of the Rack ATS in the Web browser's URL address field and press ENTER. Until HTTP is enabled, you must include `https://` in the URL. When you specify a non-default Web server port in Internet Explorer, you must include `http://` or `https://` in the URL.

### Common Browser Error Messages at Log On

Error Message	Browser	Cause of the Error
"This page cannot be displayed."	Internet Explorer	Web access is disabled, or the URL was not correct.
"Unable to connect."	Firefox	

### URL Format Examples

**NOTE:** HTTP is disabled by default, and HTTPS is enabled by default.

- For a DNS name of Web1:
  - `http://Web1` if HTTP is your access mode
  - `https://Web1` if HTTPS (HTTP with SSL/TLS) is your access mode
- For a System IP address of 139.225.6.133 and the default Web server port (80):
  - `http://139.225.6.133` if HTTP is your access mode
  - `https://139.225.6.133` if HTTPS (HTTP with SSL/TLS) is your access mode
- For a System IP address of 139.225.6.133 and a non-default Web server port (5000):
  - `http://139.225.6.133:5000` if HTTP is your access mode
  - `https://139.225.6.133:5000` if HTTPS (HTTP with SSL/TLS) is your access mode
- For a System IPv6 address of 2001:db8:1::2c0:b7ff:fe00:1100 and a non-default Web server port (5000):
  - `http://[2001:db8:1::2c0:b7ff:fe00:1100]:5000` if HTTP is your access mode
  - `https://[2001:db8:1::2c0:b7ff:fe00:1100]:5000` if HTTPS (HTTP with SSL/TLS) is your access mode

## First Log On



When you log on to the Rack ATS for the first time, you will be prompted to change the default Super User account password (**apc**). After you log in, you will be directed to the **Configuration Summary** screen. This screen is an overview of all system protocols, and their current values (e.g. enabled/disabled). You can access this screen at any time afterwards from **Configuration > Network > Summary**.

## Web UI Features

Read the following to familiarize yourself with basic Web UI features for your Rack ATS.

### Tabs

The following tabs are available:

- **Home:** Appears when you log on. View active alarms, the load status of the Rack ATS, and the most recent Rack ATS events. For more information, see [Home Tab](#), page 129.  
**NOTE: Home** is the default page when you log on. To change the login page, go to the desired login page and then click the pushpin icon  at the top right of the browser window. To change the login page back to Home, click the home target icon .
- **Status:** Gives the user the status of the **ATS** and **Network**. The **ATS** tab covers the status of **Alarms, Device, Unit, Load, Measurement, and Environment**. The **Network** tab only covers the **Network**. For more information, see [Status Tab](#), page 130.
- **Control:** The **Control** tab covers **Security** and **Network**. Much more information is covered under these tabs and will be described under [Control Tab](#), page 136.
- **Configuration:** The **Configuration** tab covers **ATS, Security, Network, Notification, General** and **Logs**. Much more information is covered under each of these tabs and will be under [Configuration Tab](#), page 138.
- **Tests:** The **Tests** tab covers **ATS** and **Network**. The **ATS** tab covers **LCD Blink** and the **Network** tab covers **LED Blink**. Both will be further described under [Tests Tab](#), page 179.
- **Logs:** The **Logs** section covers **Event, Data** and **Firewall**. The **Event** and **Data** tabs cover more information which will be further discussed under [Logs Tab](#), page 180.
- **About:** The **About** section covers **ATS, Network**, and **Support**, which will be further discussed under [About Tab](#), page 187.

### Limited Status Access



When enabled, the Limited Status page allows you to use a Web browser to view limited information about the Rack ATS without requiring a login. A link to the Login page is available at the top left of the Limited Status page.

To enable the Limited Status page, go to **Configuration > Network > Web > Access** in the Web UI.

- If you only select **Enable**, a **Limited Status** hyperlink appears towards the lower left corner of the Login page. You can click this link to view the Limited Status page without logging in to the Rack ATS.
- If you select both **Enable** and **Use as default**, the Limited Status page appears by default when you enter the IP address of the Rack ATS in the URL address bar of your Web browser.

## Device Status Icons

One or more icons and accompanying text indicate the current operating status of the Rack ATS.

Icon	Description
	<b>No Alarms:</b> No alarms are present, and the Rack ATS and NMC are operating normally.
	<b>Warning:</b> An alarm condition requires attention and could jeopardize your data or equipment if its cause is not addressed.
	<b>Critical:</b> A critical alarm exists, which requires immediate action.

At the upper right corner of every page, the quick status area displays the same icons currently displayed on the Home page to report the Rack ATS status:

- The **No Alarms** icon is displayed if no alarms exist.
- One or both of the other icons (**Critical** and **Warning**) are displayed if any alarms exist. After each icon, the number of active alarms of that severity is also displayed.

You can click any icon in the quick status area to navigate to the **Home** screen.



## Quick Links

There are three configurable links at the lower-left corner of each Web UI page. By default, the links access these Web pages:

- Link 1: The home page of APC website
- Link 2: Information on EcoStruxure™ IT
- Link 3: Additional information on IT Power Distribution equipment

You can configure these links under **Configuration > General > Quick Links**.

The following links are located in the upper-right corner of each Web UI page:

- **Your user name:** Select this link to change user preferences.
- **Current language:** Only English is supported at this time.
- **Log Off:** Select this link to log the current user off of the Web UI.
- **Help:** Select this link to view context-sensitive information.
- Pushpin icon : Click the pushpin icon to set the current Web page to be the page that displays when you first log on. Click the home target icon  to set the **Home** page as the page that displays when you first log on.

## Network Port Sharing (NPS) on the Web UI

The Web UI of the Rack ATS will have additional capabilities if the Rack ATS is part of an NPS group. This includes an NPS Group Status page (**Status > ATS > Group Status**) and an NPS Group Configuration page **Configuration > ATS > Group**. Additionally, for Web pages that support NPS features, you can view a different Rack ATS in the group by selecting the Display ID of that unit.

Each Rack ATS in the NPS group is denoted with a Rack ATS icon ➤ followed by its Display ID (1 to 32). The Rack ATS that you are logged into is displayed with an additional asterisk (\*) following the Display ID.

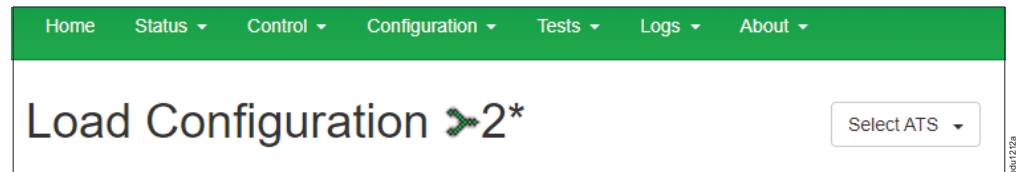

# Home Tab

**Active Alarms:** View active alarms, which will also be displayed at the top right of every page. If no alarms exist, a green check mark with the words “No Alarms Present” will show.

**Switch/Source Status:** Shows the selected source and whether switchover is possible.

**Load Status:** View the load for the device in kVA and the load for the phases and banks in A, as applicable. The meter shows the current load status: Normal (green), Near Overload (yellow), or Overload (red). Click **More** to go to the **Load Status** page (see [View Load Status](#), page 132 for more information).

**NOTE:** If a low load threshold is configured, the meter will also include a blue segment on the left.

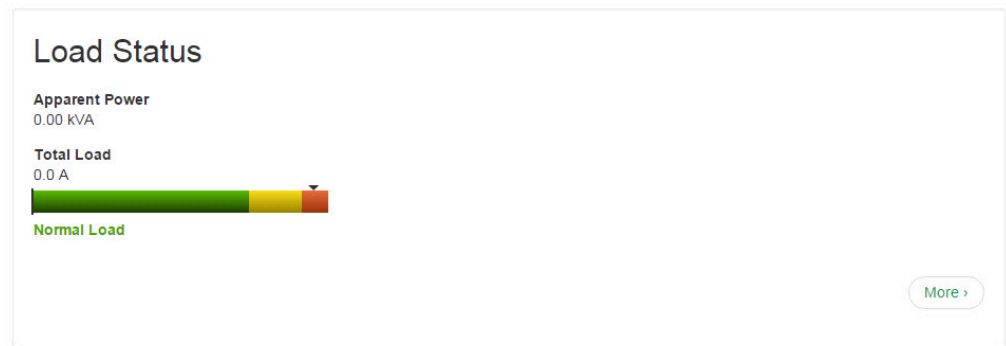

## Parameters

- **Name:** The configured name for the Rack ATS.
- **Location:** The physical location of the Rack ATS.
- **Contact:** The person responsible for the Rack ATS.
- **Model Number:** Also called SKU or part number. Acceptable voltage configurations are specific to model numbers. For details, see the *Specification Sheet* for your Rack ATS model on [www.se.com](http://www.se.com).
- **Rating:** Provides the number of metered phases and banks on the unit, in addition to the phase rating of the Rack ATS.
- **User Type:** Type of user account accessing the Rack ATS. Your user type defines what permissions you have. See *Types of User Accounts*, page 15 for details.
- **Uptime:** Amount of time the Rack ATS has been operating since the last reboot from either a power cycle or a reboot of the Management Interface.

**Recent Device Events:** View the most recent events, including the dates and times they occurred. A maximum of five events are shown at one time. Click **More Events** to go to the **Logs** tab and view the entire Event Log.

## Status Tab

Use the Status tab to view information for the Rack ATS and the network:

- **ATS:** View NPS Groups (**Group Status**) active alarms (**Alarms**), general configuration information for the Rack ATS (**Device Status**), power supply information and event counts (**Unit Status**), Load Status (**Load**), and Power Measurements (**Measurement**).
- **Network:** View IPv4/IPv6 settings, Domain Name System Status, and Port Speed.

## View NPS Groups

### Status > ATS > Group Status

You can use this page to do the following:

- View general information about each unit in an NPS Group. Select each unit to show or hide specific information about that unit, and options to change the settings for the individual unit.
- Use the **Reset/Reboot** options to return the Network Management Interfaces in the NPS group to their defaults, including TCP/IP and EAPoL settings.
  - TCP/IP and EAPoL (By default, TCP/IP is set to DHCP and EAPoL is disabled.)
  - LCD On/Off preference
  - Names for source A and B, source preference, and front panel locking
  - Frequency deviation, voltage transfer limits, transfer range, and sensitivity
  - Load thresholds, peak current measurement and timestamp
  - Event counts and timestamps for event counts
  - Wired environmental sensor: name and location, peak temperature and timestamps, alarm status (disabled/enabled), temperature/humidity thresholds and hysteresis values

This option will cause the NMC to reboot. You will be required to change the default user name and password (**apc** and **apc**) after initial log on.

- Use the **ATS to defaults** options to return Network Management Interfaces in the NPS group to their defaults, excluding TCP/IP and EAPoL settings:
  - TCP/IP and EAPoL
  - LCD On/Off preference
  - Names for source A and B, source preference, and front panel locking
  - Frequency deviation, voltage transfer limits, transfer range, and sensitivity
  - Load thresholds, peak current measurement and timestamp
  - Event counts and timestamps for event counts
  - Wired environmental sensor: name and location, peak temperature and timestamps, alarm status (disabled/enabled), temperature/humidity thresholds and hysteresis values
- Remove disconnected guests from the NPS group.

**NOTE:** To change the host unit, go to **Configuration > ATS > Groups**.

# View Device Alarms

**Path: Status > ATS > Alarms**

View current device alarms, including alarm status icons (see Device Status Icons, page 127) and descriptions.

# View Device Status

**Path: Status > ATS > Device**

The screenshot shows the Schneider Electric Automatic Transfer Switch Application interface. At the top, there is a navigation bar with the Schneider Electric logo, the text "Automatic Transfer Switch Application", the EcoStruxure IT logo with the tagline "Innovation At Every Level" and "Mobile visibility into your devices", and a "No Alarms" status indicator. Below the navigation bar is a menu with options: Home, Status, Control, Configuration, Tests, Logs, and About. The main content area is titled "Status" and contains a "Device Status" section. This section includes a "Total Load" gauge showing 0.0 A, a "Total Output Power" gauge showing 0.00 kVA, and a "Normal Load" indicator. Below these are two sections: "Properties" and "Configuration". The "Properties" section lists Model Number (AP4432A), Serial Number (ATS012345GL22), and Outlets (18). The "Configuration" section lists Name (apc20CAC1), Location (Unknown), and Contact (Unknown). A link "Configure device settings" is provided at the bottom of the configuration section.

View the **Device Status**, **Properties**, and **Configuration** information. Select **Configure device settings** to edit the **Name**, **Location**, or **Contact** information.

## View The Unit Status

Path: Status > ATS > Unit

The screenshot displays the Schneider Electric Automatic Transfer Switch Application web interface. The page title is "Unit Status". At the top, there is a navigation bar with "Home", "Status", "Control", "Configuration", "Tests", "Logs", and "About". The Schneider Electric logo and "EcoStruxure IT" branding are visible. A "No Alarms" indicator is present in the top right corner. The main content area is titled "Unit Status" and contains several sections:

- Source Status:**
  - Selected Source: Source A
  - Preferred Source: Source A
  - Source A: Selected
  - Source B: OK
- Power Supplies:**
  - Source A 24V: OK
  - Source B 24V: OK
  - Source A Boost Voltage: OK
  - Source B Boost Voltage: OK
  - 3.3V: OK
- Others:**
  - Phase Synchronization: Sync
  - Front Panel: Unlocked
- Event Counts:**
  - Redundancy Loss: 5
  - Source Switch: 27
  - Over Current: 0
  - Source Preference Change: 0
  - Spike/Dropout: 0
  - Surge/Droop: 30
  - Freq Out of Range: 0

At the bottom of the event counts section, there is a checkbox for "Reset Event Count (last reset at 12/20/2016 18:00:53)" and "Apply" and "Cancel" buttons.

Footer text includes: "APC's Web Site | Testdrive Demo | EcoStruxure™ IT" and "© 2020, Schneider Electric. All rights reserved. Site Map | Updated: 01/13/2022 at 12:18 (apc2R91c.us.ddns.schneider-electric.com)".

View the status of the primary and secondary power source, available power supplies, phase synchronization, and other available features.

View the following Event counts: **Redundancy Loss**, **Source Switch**, **Over Current**, **Source Preference Change**, **Spike/Dropout**, **Surge/Droop**, and **Frequency Out of Range**. To reset these counts to 0, select **Reset Event Count** and click **Apply**. Event counts are set to zero automatically if power is removed from the device or if the Rack ATS controller is updated.

## View Load Status

Path: Status > ATS > Load

A marker on a colored green, yellow, and red sliding bar represents the Rack ATS load.

- Green: Normal load range
- Yellow: Near overload range
- Red: Overload range

# View Power Measurements

Path: Status > ATS > Measurement

Schneider Electric Automatic Transfer Switch Application EcoStruxure IT Innovation At Every Level Mobile visibility into your devices No Alarms

apc | English | Log Off | Help

Home Status Control Configuration Tests Logs About

## Status

ATS Measurement

Input Frequency

Source A	Source B
60 Hz	60 Hz

Input Voltage (AC)

Source A	Source B
226 V	223 V

Power Supplies (DC)

Source A 24V Power Supply	Source B 24V Power Supply
24 V	23 V
Source A Boost Voltage	Source B Boost Voltage
48 V	48 V
3.3V Power Supply	
3.4 V	

APC's Web Site | Testdrive Demo | EcoStruxure™ IT © 2021, Schneider Electric. All rights reserved. Site Map | Updated: 09/09/2021 at 20:13 (apc20ca01.us.ddns.schneider-electric.com)

View measurements for **Input Frequency**, **Input Voltage (AC)**, and **Power Supplies (DC)**.

**NOTE:** The **Power Supplies (DC)** are internal to the Rack ATS—they do not come from connected hardware. Customer support may use these readings for troubleshooting.

# View Environment Status

This page allows you to view the following settings and feedback from a connected Temperature Sensor (AP9335T) or Temperature/Humidity Sensor (AP9335TH): **Sensor Name**, **Sensor Location**, **Sensor Type**, **Alarm Status**, **Temperature**, **Peak Temperature**, **Peak Time**, **Reset Time**, **Humidity**, and whether the **Temperature Alarms** and **Humidity Alarms** have been **Enabled** or **Disabled**.

You can configure these settings by clicking **Configure environment settings** or going to **Configuration > ATS > Environment**. See *Configure Temperature and Humidity Sensors*, page 145 for more information.

# View Network Status

Path: Status > Network > Network



Automatic Transfer Switch Application



No Alarms

apc | English | Log Off | Help

Home Status Control Configuration Tests Logs About

## Status

### Current IPv4 Settings

System IP 10.218.117.199	Subnet Mask 255.255.255.0	Default Gateway 10.218.117.1	MAC Address 00 C0 B7 D8 F0 74
Mode DHCP	DHCP Server: 10.218.99.23	Lease Acquired 09/17/2020 09:38	Lease Expires 09/20/2020 09:37

### Current IPv6 Settings

Type	IP Address	Prefix Length
Auto	FE80::2C0:B7FF:FED8:F074	64

### Domain Name System Status

Active Primary DNS Server 10.169.10.10	Active Secondary DNS Server 10.218.99.55	Active Host Name apcD8F074
Active Domain Name (IPv4/IPv6) nam.gad.schneider-electric.com	Active Domain Name (IPv6) example.com	

### Port Speed

Current Speed  
100 Full-Duplex

[APC's Web Site](#) | [Testdrive Demo](#) | [EcoStruxure™ IT](#)

© 2020, Schneider Electric. All rights reserved.  
Site Map | Updated: 09/17/2020 at 10:12 (apcs074.us.dns.schneider-electric.com)

### Current IPv4 Settings

- **System IP:** The IP address of the unit.
- **Subnet Mask:** The IP address of the sub-network.
- **Default Gateway:** The IP address of the router used to connect to the network.
- **MAC Address:** The MAC address of the unit.
- **Mode:** How the IPv4 settings are assigned: **Manual**, **DHCP**, or **BOOTP**.
- **DHCP Server:** The IP address of the DHCP server. This is only displayed if Mode is DHCP.
- **Lease Acquired:** The date/time that the IP address was accepted from the DHCP server.
- **Lease Expires:** The date/time the IP address from the DHCP server expires and will need to be renewed.

### Current IPv6 Settings

- **Type:** How the IPv6 settings are assigned: automatic or manual.
- **IP Address:** The IP address of the unit.
- **Prefix Length:** The range of addresses for the sub-network.

### Domain Name System Status

- **Active Primary DNS Server:** The IP address of the primary DNS server.
- **Active Secondary DNS Server:** The IP address of the secondary DNS server.
- **Active Host Name:** The host name of the active DNS server.
- **Active Domain Name (IPv4/IPv6):** The IPv4/IPv6 domain name that is currently in use.
- **Active Domain Name (IPv6):** The IPv6 domain name that is currently in use.

### Port Speed

**Current Speed:** The current speed assigned to the Ethernet port in Mbps, with the option of **half-duplex** (communication in only one direction at a time) or **full-duplex** (communication in both directions on the same channel simultaneously).

# Control Tab

The **Control** tab options enable you to take immediate actions affecting active user management and the security of your network.

## Manage User Sessions

**Path: Control > Security > Session Management**

The screenshot shows the 'Session Management' page. At the top is a green navigation bar with links: Home, Status, Control, Configuration, Tests, Logs, and About. Below the navigation bar is the heading 'Current Sessions'. The main content area is titled 'Session Management' and contains a table with the following data:

User	Interface	Address	Logged In Time
apc	Secure Web	10.252.80.231	00:00:01

The **Session Management** menu displays all active users currently connected to the Rack ATS. To view Information about a user, select their user name. The **Session Details** screen displays basic information about the user including the interface they are logged in to, their IP address, and log in time. At the bottom of the **Session Details** page, there is a **Terminate Session** button. The Administrator can terminate the session of another user.

## Web CLI

**Path: Control > Network > Web CLI**

The screenshot shows the 'Web CLI' page. At the top is a green navigation bar with links: Home, Status, Control, Configuration, Tests, Logs, and About. The page header includes the Schneider Electric logo, 'Automatic Transfer Switch Application', the EcoStruxure IT logo with the tagline 'Innovation At Every Level' and 'Mobile visibility into your devices', and user information: 'apc | English | Log Off | Help'. A notification icon shows 2 alerts.

### Web CLI

```
(C) Copyright 2025 All Rights Reserved ATSSG APP v3.3.0-1_11
-----
Name       : apc65E286                               Date : 07/08/2025
Contact    : unknown                                 Time : 05:35:41
Location   : unknown                                 User  : Super User
Up Time    : 0 Days 0 Hours 28 Minutes                Stat  : Pa-IdA-164-A4
-----
IPv4       : Enabled                                 IPv6       : Enabled
Ping Response : Enabled
-----
HTTP       : Disabled                                 HTTPS      : Enabled
FTP        : Disabled                                 Telnet     : Disabled
SSH/SCP    : Enabled                                 SNMPv1    : Disabled
SNMPv3    : Disabled
-----
Super User : Enabled                                 User Authentication: Local
Administrator : Disabled                             Device User : Disabled
Read-Only User : Disabled                             Network-only User : Disabled

Type ? for command listing
Use tcpip command for IP address(-i), subnet(-s), and gateway(-g)
apc>
```

This section provides a web-based command line interface (CLI) for the currently logged in user. All Telnet CLI commands can be executed directly through the Web CLI. For detailed descriptions and syntax of available commands, see [Network Management Card Command Descriptions, page 49](#) and [Device Command Descriptions, page 90](#).

# Reset the Network Interface

Path: Control > Network > Reset/Reboot

APC's Web Site | Testdrive Demo | EcoStruxure™ IT

© 2020, Schneider Electric. All rights reserved.  
Site Map | Updated: 09/17/2020 at 11:11 (apcd8f074.us.ddns.schneider-electric.com)

This menu gives you the option to reset and reboot various components of the network interface.

Setting	Description
<b>Reboot Management Interface</b>	Rebooting only restarts the Rack ATS unit's Network Management Interface; it does not affect the ON/Off status of the Rack ATS.
<b>Reset All</b>	Returns all Network interfaces to their default settings. Use the default user name and password ( <b>apc</b> ) to log on after a reset. You will then be required to change your user name and password.  Clear the <b>Exclude TCP/IP</b> checkbox to reset all configuration values; mark the <b>Exclude TCP/IP</b> checkbox to reset all values except TCP/IP and EAPoL. The default TCP/IP setting is DHCP. The default for EAPoL access is <b>Disabled</b> .
<b>Reset Only</b>	Reset one or both of the following settings: <ul style="list-style-type: none"> <li>• <b>TCP/IP:</b> Resets only the setting that determines how the Rack ATS must obtain its TCP/IP configuration values, including the EAPoL configuration. The default TCP/IP setting is DHCP. The default for EAPoL access is <b>Disabled</b>.</li> <li>• <b>Event Configuration:</b> Resets events to their default configuration. Any specially configured event or group will also revert to the default value.</li> <li>• <b>Transfer Switch Configuration:</b> Resets the following configurations without changing network configurations such as enabled interfaces and login credentials: <ul style="list-style-type: none"> <li>◦ LCD On/Off preference</li> <li>◦ Names for source A and B, source preference, and front panel locking</li> <li>◦ Frequency deviation, voltage transfer limits, transfer range, and sensitivity</li> <li>◦ Load thresholds, peak current measurement and timestamp</li> <li>◦ Event counts and timestamps for event counts</li> <li>◦ Wired environmental sensor: name and location, peak temperature and timestamps, alarm status (disabled/enabled), temperature/humidity thresholds and hysteresis values</li> </ul> </li> </ul> Resetting may take up to a minute.

**NOTE:** This page only resets the current Rack ATS. For options to Reset/Reboot units in an NPS group, see **Configuration > ATS > Groups** and **Status > ATS > Group Status**.

---

# Configuration Tab

Use the Configuration tab to do any of the following:

- Configure settings related to NPS groups, unit identification, power settings, and switching behavior (see [Configure the Rack ATS](#), page 139).
- Configure settings related to security and user management (see [Manage Security Settings](#), page 147).
- Configure settings related to Network connectivity and access to the Web UI/CLI (see [Configure Network Settings](#), page 156).
- Configure Notifications (see [Configure Notifications](#), page 169).
- Configure general settings related to the Network Management Interface (see [General Configuration](#), page 174).

# Configure the Rack ATS

## Configure NPS Groups

Configuration > ATS > Groups

**Schneider Electric** Automatic Transfer Switch Application **EcoStruxure IT** Innovation At Every Level Mobile visibility into your device **No Alarms** apc | English | Log Off | Help |

Home Status - Control - Configuration - Tests - Logs - About -

### Group Configuration

#### Network Port Sharing (NPS) Host Configuration

**Note:**

- When resetting to defaults for a guest device with active alarms, these alarms may continue to be reported as active by the host until the host has rebooted.
- In order to change the host designation in an NPS group, the guest unit that will be selected to become the host must have an active network link.

Host 1  Guest 2  Guest 3

APC's Web Site | EcoStruxure™ IT | Product Information © 2022, Schneider Electric. All rights reserved. Site Map | Updated: 07/27/2022 at 15:17 (apc2fadf2.us.ddns.schneider-electric.com)

You can use this page to do the following:

- View general information about each unit in an NPS Group. Select each unit to show or hide specific information about that unit, and options to change the settings for the individual unit.
- Use the **Reset/Reboot** options to return the Network Management Interfaces in the NPS group to their defaults, including TCP/IP and EAPoL settings.
  - TCP/IP and EAPoL (By default, TCP/IP is set to DHCP and EAPoL is disabled.)
  - LCD On/Off preference
  - Names for source A and B, source preference, and front panel locking
  - Frequency deviation, voltage transfer limits, transfer range, and sensitivity
  - Load thresholds, peak current measurement and timestamp
  - Event counts and timestamps for event counts
  - Wired environmental sensor: name and location, peak temperature and timestamps, alarm status (disabled/enabled), temperature/humidity thresholds and hysteresis values

This option will cause the NMC to reboot. You will be required to change the default user name and password (**apc** and **apc**) after initial log on.

- Use the **ATS to defaults** options to return Network Management Interfaces in the NPS group to their defaults, excluding TCP/IP and EAPoL settings:
  - TCP/IP and EAPoL
  - LCD On/Off preference
  - Names for source A and B, source preference, and front panel locking
  - Frequency deviation, voltage transfer limits, transfer range, and sensitivity
  - Load thresholds, peak current measurement and timestamp
  - Event counts and timestamps for event counts
  - Wired environmental sensor: name and location, peak temperature and timestamps, alarm status (disabled/enabled), temperature/humidity thresholds and hysteresis values
- Remove disconnected guests from the NPS group.
- Select a new host unit by using the **Select Host** option. This option is only available when the target host has a network connection, indicated by a link icon .

## Configure Rack ATS Name and Location

**Path:** Configuration > ATS > Device

**Status:** View the Rack ATS load in A and the Output Power in kVA.

**Name:** Enter a descriptive name for the Rack ATS. This will appear on the **Home** tab.

**Location:** Enter the physical location of the Rack ATS. This will appear on the **Home** tab.

**Contact:** Enter the person responsible for the Rack ATS. This will appear on the **Home** tab.

Click **Apply** to save your changes or **Cancel** to discard your changes.

## Set Preferred Power Source

**Path:** Configuration > ATS > Source

**Status:** View the status of the preferred power source.

**Source A Name, Source B Name:** Enter names of your choice for Source A and Source B.

**Preferred Source:** Select the power source the Rack ATS will draw from when both sources are available.

**Front Panel:** Lock or unlock the Front Panel.

Click **Apply** to save your changes or **Cancel** to discard your changes.

## Configure Switching Behavior

Path: Configuration > ATS > Frequency/Voltage

### DANGER

#### HAZARDOUS VOLTAGE

Do not operate the Rack ATS outside Rated Voltage (+/- 10%). Voltage limits and transfer ranges represent software control of switching behavior, not input voltages for use.

**Failure to follow these instructions will result in death or serious injury.**

Model	Rated Voltage (VAC)	Configurable Ranges (VAC)	Narrow Default Range (VAC)	Medium Default Range (VAC)	Wide Default Range (VAC)
AP4421A	230 (L-N)	± 16–25 V	± 16 V	± 20 V	± 25 V
AP4422A	230* (L-N)	± 16–25 V	± 16 V	± 20 V	± 25 V
AP4423A	230* (L-N)	± 16–25 V	± 16 V	± 20 V	± 25 V
AP4424A	230 (L-N)	± 16–25 V	± 16 V	± 20 V	± 25 V
AP4430A	200/208 (L-L)	± 15–30 V	± 15 V	± 22 V	± 30 V
AP4431A	208 (L-L)	± 15–30 V	± 15 V	± 22 V	± 30 V
AP4432A	200/208 (L-L)	± 15–30 V	± 15 V	± 22 V	± 30 V
AP4433A	208 (L-L)	± 15–30 V	± 15 V	± 22 V	± 30 V
AP4434A	208 (L-L)	± 15–30 V	± 15 V	± 22 V	± 30 V
AP4450A	100/120 (L-N)	± 10–23 V	± 10 V	± 16 V	± 23 V
AP4450AJ	100 (L-N)	± 10–15 V	± 10 V	± 12 V	± 15 V
AP4452A	120 (L-N)	± 10–23 V	± 10 V	± 16 V	± 23 V
AP4452AJ	100 (L-N)	± 10–15 V	± 10 V	± 12 V	± 15 V
AP4453A	120 (L-N)	± 10–23 V	± 10 V	± 16 V	± 23 V

\*220 V, Korea only.

The voltage transfer range determines the switching behavior for the Rack ATS based on source voltage. When the source voltage goes outside the specified range, the Rack ATS switches to the secondary power source. You can configure Narrow, Medium, or Wide voltage ranges and then set the Rack ATS to the desired range. Ensure that your power sources provide the appropriate power for the Rack ATS (+/- 10% of the Rated Voltage), and use the voltage transfer range to ensure that the Rack ATS does not operate outside the appropriate voltage for extended periods of time.

## Frequency/Voltage Configuration

### Configuration

**Line Frequency**  
60 Hz

**Frequency Deviation**

3 Hz  
 5 Hz  
 10 Hz

**Line VRMS [108 to 132]**  
120 Vrms

**VRMS Wide Limit [10 to 23]**  
23 V

**VRMS Medium Limit [10 to 23]**  
16 V

**VRMS Narrow Limit [10 to 23]**  
10 V

**Sensitivity**

High  
 Low

**Voltage Transfer Range**

Wide  
 Medium  
 Narrow

[APC's Web Site](#) | [Testdrive Demo](#) | [EcoStruxure™ IT](#)

 © 2021, Schneider Electric. All rights reserved.  
[Site Map](#) | Updated: 01/16/2022 at 21:30 (apc2tedf2.us.doms.schneider-electric.com)

**Frequency Deviation:** Frequency deviation beyond the set value will cause the Rack ATS to switch power sources.

**NOTE:** If the frequency is at 50 Hz (see [View Power Measurements](#), page 133) and the **Sensitivity** is set to **High**, this value should be 3 or 5.

**Line VRMS:** Rated voltage for the Rack ATS (also called Nominal Input). VRMS limits and transfer ranges are based on this value.

**Sensitivity:** Control how much power fluctuation the Rack ATS tolerates before switching to the secondary power source. With a **Low** sensitivity, the Rack ATS waits 4 milliseconds (ms) before switching to the alternate power source. (This can help prevent excessive switching if your source voltage has excessive or frequent fluctuation.) With a **High** sensitivity, the Rack ATS waits 2 ms before switching to the alternate power source.

**NOTE:** If the frequency is at 50 Hz and the **Frequency Deviation** is set to 10, **Sensitivity** should be set to **Low**.

**Limits and Transfer Range:** The **Transfer Range** is the **Line VRMS** plus or minus a configured **Limit (Wide, Medium, or Narrow)**. The **Transfer Range** determines the switching behavior for the Rack ATS based on source voltage: when the source voltage moves outside the **Transfer Range**, the Rack ATS switches to the secondary power source.

- **VRMS Wide, Medium, and Narrow Limit:** set configuration options for the **Transfer Range**.
- **Transfer Range:** Decide whether the Rack ATS will switch power sources based on the **Wide, Medium, or Narrow VRMS Limit**. The **Transfer Range** can only be set to one **Limit** at a time.

**NOTE:** The **Voltage Transfer Range** and **Limit** must remain within the absolute maximum ratings of the Rack ATS: 85–265 VRMS. At any voltage below 85 VRMS or above 265 VRMS, the Rack ATS will switch power sources regardless of configuration.

**Example:** A Rack ATS is set to the following configuration:

**Line VRMS** = 208,

**VRMS Wide Limit** = 10,

**Transfer Range** = Wide.

The Rack ATS will switch sources when the voltage goes below 198 VRMS or above 218 VRMS (208 ±10 VRMS).

Click **Apply** to save your changes or **Cancel** to discard your changes.

# Configure Load Thresholds

Path: Configuration > ATS > Load

The screenshot shows the 'Load Configuration' page in the Schneider Electric Automatic Transfer Switch Application. The page is divided into two main sections: 'Status' and 'Configuration'.

**Status Section:**

- Current:** 0.5 A
- Normal Load:** Indicated by a green bar on the meter.
- Peak Current:** 0.7 A

**Configuration Section:**

- Low Load Warning [0 to 16]:** 0 A
- Near Overload Warning [0 to 16]:** 12 A
- Overload Alarm [0 to 16]:** 16 A
- Peak Current:**  Reset (last reset at 09/17/2020 09:30:34)
- Buttons:** Apply, Cancel

Footer text: APC's Web Site | Testdrive Demo | EcoStruxure™ IT | © 2020, Schneider Electric. All rights reserved. Site Map | Updated: 09/17/2020 at 09:54 (apcd9074.us.doms.schneider-electric.com)

**Status:** View the current in A, and the Peak Current in kVA, for the device, phases, and banks. The indicator in the green, yellow, and red meter shows the load status: normal, near overload, or overload.

**Load Thresholds:** The Rack ATS generates an alarm when any bank exceeds its rated value. Set the number of amps to trigger a **Low Load Warning**, **Near Overload Warning**, and **Overload Alarm**.

**NOTE:** If a circuit breaker trips, there is no definitive indication that the circuit breaker is open. However, the current for that bank will drop. Set the **Low Load Warning** to 1 A for these reasons :

- The default setting for the **Low Load Warning** is 0 amps. This effectively disables the warning; with this setting, the Web UI will not indicate that a circuit breaker may have been tripped.
- A 1-A detection threshold for the **Low Load Warning** will help to indicate that a circuit breaker may have tripped.

**Peak Current:** Reset the peak current.

Click **Apply** to save your changes or **Cancel** to discard your changes.

## Turn the LCD Display On or Off

**Path: Configuration > ATS > LCD On/Off**

Select whether you want the LCD Screen to be **On** or **Off**, then click **Apply**.

## Configure Temperature and Humidity Sensors

**Path: Configuration > ATS > Environment**

**NOTE:** To use this feature, you must have connected an optional APC Temperature Sensor (AP9335T) or APC Temperature/Humidity Sensor (AP9335TH) to the Rack ATS.

At the top of this page, you can see whether a Temperature or Temperature and Humidity sensor is connected (**Sensor Type**), the current **Temperature** and/or **Humidity** readings from the sensor, and the **Alarm Status** of the sensor. You can also click the thermometer icon  in the upper-right corner of the page to toggle between Fahrenheit and Celsius.

## About Temperature and Humidity Settings

### General settings:

- **Sensor Name:** Enter a custom name for the sensor.
- **Sensor Location:** Enter the location of the sensor.

### Temperature settings:

- If the **High Temperature Threshold** is reached and **Temperature Alarms** are set to **Enabled**, the system generates a Warning alarm.
- If the **Maximum Temperature Threshold** is reached and **Temperature Alarms** are set to **Enabled**, the system generates a Critical alarm.
- The **Peak Temperature** is the highest temperature recorded since the last **Reset**. **Peak Time** shows the time and date when the **Peak Temperature** was recorded.

### Humidity settings:

- If the **Low Humidity** threshold is reached and **Humidity Alarms** are set to **Enabled**, the system generates a Warning alarm.
- If the **Minimum Humidity** threshold is reached and **Humidity Alarms** are set to **Enabled**, the system generates a Critical alarm.

**Hysteresis:** This value specifies how far past a threshold the temperature or humidity must return to clear a threshold violation.

- For Maximum and High temperature threshold violations, the clearing point is the threshold minus the hysteresis.
- For Minimum and Low humidity threshold violations, the clearing point is the threshold plus the hysteresis.

Increase the value for Temperature Hysteresis or Humidity Hysteresis to avoid multiple alarms if temperature or humidity that has caused a violation then wavers slightly up and down. If the hysteresis value is too low, such wavering can cause and clear a threshold violation repeatedly.

*Example of rising but wavering temperature:* The maximum temperature threshold is 85 °F, and the temperature hysteresis is 3 °F. The temperature rises above 85 °F, violating the threshold. It then wavers down to 84 °F and then up to 86 °F repeatedly, but no clearing event and no new violation occur. For the existing violation to clear, the temperature would have to drop to 82 °F (3 °F below the threshold).

*Example of falling but wavering humidity:* The minimum humidity threshold is 18%, and the humidity hysteresis is 8%. The humidity falls below 18%, violating the threshold. It then wavers up to 24% and down to 13% repeatedly, but no clearing event and no new violation occur. For the existing violation to clear, the humidity would have to rise to above 26% (8% past the threshold).

## To Configure Temperature and Humidity Sensors

1. Enter values for the Temperature and Humidity thresholds.
2. Enter the **Hysteresis** values.
3. Enable alarm generation as desired.
4. Click **Apply**.

# Manage Security Settings

## Manage Settings for User Sessions

Path: Configuration > Security > Session Management

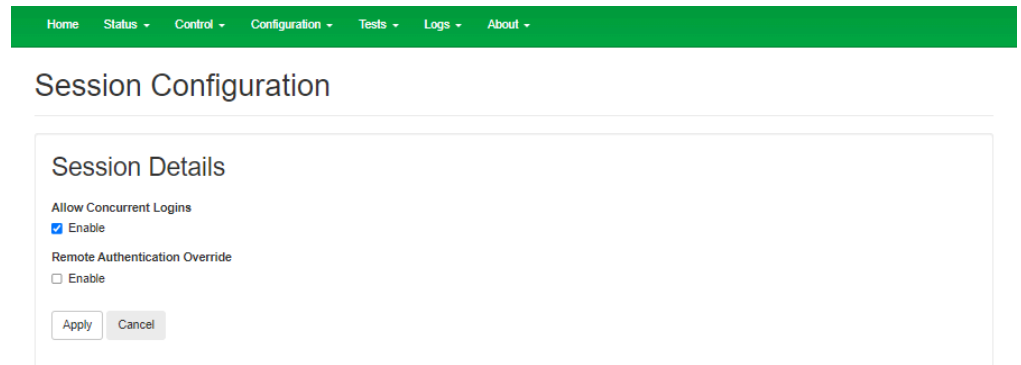

The screenshot shows a web interface for Session Configuration. At the top is a green navigation bar with links: Home, Status, Control, Configuration, Tests, Logs, and About. Below the navigation bar is the title "Session Configuration". The main content area is titled "Session Details" and contains two settings:

- Allow Concurrent Logins:** A checkbox labeled "Enable" is checked.
- Remote Authentication Override:** A checkbox labeled "Enable" is unchecked.

At the bottom of the form are two buttons: "Apply" and "Cancel".

**Allow Concurrent Logins:** Select **Enable** to allow two or more users to log on at the same time. Each user has equal access and each interface (HTTP, FTP, telnet, serial connection, etc.) counts as a logged-in user.

**Remote Authentication Override:** The Rack ATS supports RADIUS storage of passwords on a server. However, if you enable this override, the Rack ATS will allow a local user to log on using the password stored locally on the Rack ATS. For more information, see [Manage Local User Settings](#), page 148 and [Manage Remote User Settings](#), page 151.

## Enable Ping Response

**Path:** Configuration > Security > Ping Response

**IPv4 Ping Response:** Select the **Enable** check box to allow the Rack ATS to respond to network pings. Clear the check box to disable a Rack ATS response. If the ping response is enabled and the Rack ATS does not respond, see “Unable to ping the ATS”, page 193 under Access Problems, page 193.

This does not apply to IPv6.

## Manage Local User Settings

**Path:** Configuration > Security > Local Users > Management

The screenshot shows the 'User Management Configuration' page. At the top is a green navigation bar with the following items: Home, Status, Control, Configuration, Tests, Logs, and About. Below this is the main heading 'User Management Configuration'. The page is divided into two main sections:

- Super User Management:** A table with three columns: User Name, User Type, and User Description. It contains one entry: 'apc' (User Name), 'Super User' (User Type), and 'User Description' (User Description).
- General User Management:** A table with three columns: User Name, User Type, and User Description. It contains two entries: 'device' (User Name, Device User Type, User Description) and 'readonly' (User Name, Read-Only User Type, User Description). Below this table is an 'Add User' button.

Click **Add User** to add a new user, or select a **User Name** to edit that user's configuration:

- **Access:** Select the **Enable** check box to allow access to the Rack ATS.
- **User Name:** Enter a new user name.
- **Current Password, New Password, Confirm Password:** Enter a new password in both the New Password and Confirm Password fields. You must enter a password for new users. Blank passwords, (passwords with no characters) are not allowed.

**NOTE:** The maximum length for both the name and password is 64 bytes, with less than 64 characters for multi-byte characters. Values greater than 64 bytes for **Name** and **Password** may be truncated. To change an Administrator/Super User setting, you must enter all three fields.

- **User Type:** Select the user type from the drop-down list.

Option	Description
<b>Administrator</b>	Read-write access to all menus.
<b>Device</b>	Read-write access to device-related menus. Can be enabled or disabled by Administrators.
<b>Read-Only</b>	Read-only access. Can be enabled or disabled by Administrators.
<b>Network-Only</b>	Read-write access to network-related menus. Can be enabled or disabled by Administrators.

- **User Description:** Enter any additional identification details here.
- **Session Timeout:** Enter the number of minutes (3 by default) the Rack ATS waits before logging off an inactive user. If you change this value, you must log off for the change to take effect.

**NOTE:** If a user closes the Web UI without logging off, they are still considered logged on for the time specified in the **Session Timeout** field. This can help prevent other users from taking the place of a user who leaves the Web UI.

- **Serial Remote Authentication Override:** Use Serial Remote Authentication Override to bypass RADIUS by using the serial console (CLI) connection. This screen enables Serial Remote Authentication Override for the selected user, but, in order to work, it must also be enabled globally through the Session Management screen (see [Manage User Sessions](#), page 136).
- **User Preferences:**

Option	Description
<b>Event Log Color Coding</b>	Mark the check box to enable color-coding of alarm text recorded in the Event Log. System event entries and configuration change entries do not change color. <b>Red:</b> Alarm Severity = Critical. A critical alarm exists, which requires immediate action. <b>Orange:</b> Alarm Severity = Warning. An alarm condition requires attention and could jeopardize your data or equipment if its cause is not addressed. <b>Green:</b> Alarm Cleared. The conditions that caused the alarm have improved. <b>Black:</b> No alarms are present. The Rack ATS and all connected devices are operating normally.
<b>Export Log Format</b>	Configure which format the Event Log should be displayed in when exported (downloaded). Tab (default) allows fields to be tab-delimited whereas CSV is comma-separated.
<b>Temperature scale</b>	Select the default temperature scale, US Customary (Fahrenheit) or Metric (Celsius).
<b>Date Format</b>	Select the numerical format in which to display all dates in this user interface. In the selections, each letter (m for month, d for day, and y for year) represents one digit. Single digit days and months are displayed with a leading zero.

Click **Next**, and then click **Apply** to save or **Cancel** to return to the User Management Configuration page.

## Configure Default User Settings

### Path: Configuration > Security > Local Users > Default Settings

Determine the default values to populate in each of the fields when the Super User or Administrator-level account creates a new user. These values can be changed before the settings are applied to the system.

For remote users (user accounts not stored in the system that are remotely authenticated such as RADIUS) these are the values used for those that are not provided by the authenticating server. For example, if a RADIUS server does not provide the user with a temperature preference, the value defined in this section will be used.

- **Access:** Select the **Enable** check box to allow access to the Rack ATS.
- **User Type:** Select the user type from the drop-down list.

Option	Description
<b>Administrator</b>	Read-write access to all menus.
<b>Device</b>	Read-write access to device-related menus. Can be enabled or disabled by Administrators.
<b>Read-Only</b>	Read-only access. Can be enabled or disabled by Administrators.
<b>Network-Only</b>	Read-write access to network-related menus. Can be enabled or disabled by Administrators.

- **User Description:** Enter any additional identification details here.
- **Session Timeout:** Enter the number of minutes (3 by default) the Rack ATS waits before logging off an inactive user. If you change this value, you must log off for the change to take effect.

**NOTE:** If a user closes the Web UI without logging off, they are still considered logged on for the time specified in the **Session Timeout** field. This can help prevent other users from taking the place of a user who leaves the Web UI.

- **Bad Login Attempts:** Set the number of failed login attempts the user can have. Select from 0 to 99 attempts. 0 = unlimited.
- **User Preferences:**

Option	Description
<b>Event Log Color Coding</b>	Mark the check box to enable color-coding of alarm text recorded in the Event Log. System event entries and configuration change entries do not change color. <b>Red:</b> Alarm Severity = Critical. A critical alarm exists, which requires immediate action. <b>Orange:</b> Alarm Severity = Warning. An alarm condition requires attention and could jeopardize your data or equipment if its cause is not addressed. <b>Green:</b> Alarm Cleared. The conditions that caused the alarm have improved. <b>Black:</b> No alarms are present. The Rack ATS and all connected devices are operating normally.
<b>Export Log Format</b>	Configure which format the Event Log should be displayed in when exported (downloaded). Tab (default) allows fields to be tab-delimited whereas CSV is comma-separated.
<b>Temperature scale</b>	Select the default temperature scale, US Customary (Fahrenheit) or Metric (Celsius).
<b>Date Format</b>	Select the numerical format in which to display all dates in this user interface. In the selections, each letter (m for month, d for day, and y for year) represents one digit. Single digit days and months are displayed with a leading zero.

- **Password Requirements:**

Option	Description
<b>Strong Passwords</b>	Configure whether new passwords created for user accounts will require at least one lowercase character, one uppercase character, one number, and one symbol.
<b>Password Policy</b>	Enter the number of days after which users will be required to change their passwords. A value of 0 days (the default) disables this feature.

## Manage Remote User Settings

**Path: Configuration > Security > Remote Users > Authentication**

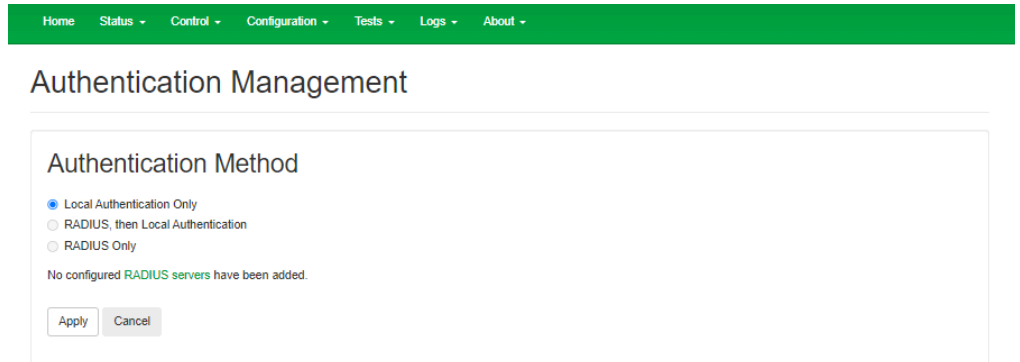

APC supports the authentication and authorization functions of RADIUS (Remote Access Dial-In User Service).

- When a user accesses a Rack ATS that has RADIUS enabled, an authentication request is sent to the RADIUS server to determine the user’s permission level.
- RADIUS user names used with the Rack ATS are case-sensitive, and have a 64 byte maximum, supporting up to 64 ASCII characters; less for multi-byte languages. Passwords with no characters (blank passwords) are not allowed.

Specify how you want remote users to be authenticated at logon. Select one of the following:

- **Local Authentication Only:** RADIUS is disabled. Local authentication is enabled.
- **RADIUS, then Local Authentication:** RADIUS and local authentication are enabled. Authentication is requested from the RADIUS server first. If the RADIUS server fails to respond, local authentication is used.
- **RADIUS Only:** RADIUS is enabled. Local authentication is disabled.

**NOTE:** If **RADIUS Only** is selected, and the RADIUS server is unavailable or improperly configured, remote access is unavailable to all users. You must use a serial connection to the CLI and change the **access** setting to **local** or **radiusLocal** to regain access. For example, the command to change the access setting to **local** would be `radius -a local`.

For information about local authentication (not using the centralized authentication of a RADIUS server), see the *Security Handbook* on [www.se.com](http://www.se.com).

## Configure a RADIUS Server

### Path: Configuration > Security > Remote Users > RADIUS

Use this option to do the following:

- List the RADIUS servers (a maximum of two) available to the Rack ATS and the Reply Timeout period for each.
- Select a server, and configure the parameters for authentication by a new RADIUS server.
- Select a listed RADIUS server to display and modify its parameters.

Setting	Definition
<b>RADIUS Server</b>	The server name or IP address (IPv4 or IPv6) of the RADIUS server. Select a link to configure the server.
<b>Port</b>	The port the RADIUS server uses to authenticate users (1812 by default). The Rack ATS supports ports 1812, and 5000 to 32768.
<b>Secret</b>	The shared secret between the RADIUS server and the Rack ATS.
<b>Reply Timeout</b>	The time in seconds that the Rack ATS waits for a response from the RADIUS server.
<b>Test Settings</b>	Enter the Super User or Administrator user name and password to test the RADIUS server path that you have configured.
<b>Skip Test and Apply</b>	Do not test the RADIUS server path. (Not recommended)

**Summary of the configuration procedure:** You must configure your RADIUS server to work with the Rack ATS. For examples of the RADIUS users file with Vendor Specific Attributes (VSAs) and an example of an entry in the dictionary file on the RADIUS server, see the *Security Handbook* on [www.se.com](http://www.se.com).

1. Add the IP address of the Rack ATS to the RADIUS server client list (file).
2. Users must be configured with Service-Type attributes unless Vendor Specific Attributes (VSAs) are defined. If no Service-Type attributes are configured, users will have read-only access (on the Web UI only). See your RADIUS server documentation for information about the RADIUS users file, and see the *Security Handbook* (on [www.se.com](http://www.se.com)) for an example.
3. VSAs can be used instead of the Service-Type attributes provided by the RADIUS server. VSAs require a dictionary entry and a RADIUS users file. In the dictionary file, define names for ATTRIBUTE and VALUE keywords, but not for numeric values. If you change numeric values, RADIUS authentication and authorization will fail. VSAs take precedence over standard RADIUS attributes.

**Configuring a RADIUS server on UNIX® with shadow passwords:** If UNIX shadow password files are used (`/etc/passwd`) with the RADIUS dictionary files, the following two methods can be used to authenticate users:

- If all UNIX users have administrative privileges, add the following to the RADIUS “user” file. To allow only Device Users, change the APC-Service-Type to `Device`.

```
DEFAULTAuth-Type = System
APC-Service-Type = Admin
```

- Add user names and attributes to the RADIUS “user” file, and verify the password against `/etc/passwd`. The following example is for users `bconners` and `thawk`:

```
bconnersAuth-Type = System
APC-Service-Type = Admin
thawkAuth-Type = System
APC-Service-Type = Device
```

**Supported RADIUS servers:** FreeRADIUS v1.x and v2.x, and Microsoft Server 2008 and 2012 Network Policy Server (NPS) are supported. Other commonly available RADIUS applications may work but may not have been fully tested.

**NOTE:** See the *Security Handbook* for more information on using RADIUS.

## Firewall Menus

### Path: Configuration > Security > Firewall > Configuration

Enable or disable the firewall functionality. The configured policy is listed by default. Select the **Enable** check box to enable the firewall. The check box is un-checked by default.

- Click **Apply** to confirm a firewall policy you have selected to enable. The **Firewall Confirmation** page will open.
  - The **Confirmation** page contains a recommendation to test the firewall before enabling. It is not mandatory.
  - The first hyperlink goes to the **Firewall Policy** page.
  - The second hyperlink goes to the **Firewall Test** page.
  - Click **Apply** to enable the firewall and return to the **Configuration** page.
  - Click **Cancel** to return to the **Configuration** page without enabling the firewall.
- Click **Cancel**: No new selection will be enabled. You stay on the **Configuration** page.

## Active Policy

### Path: Configuration > Security > Firewall > Active Policy

Select an active policy from the **Available Policies** drop-down list, and view the validity of that policy. The current active policy is displayed by default; you can select another from the list.

- Click **Apply** to enable your changes. If a different firewall was selected and enabled, the change is effective immediately. If a newly configured firewall policy has been selected, it is recommended that you test the new firewall before enabling it. (You can test the new firewall from **Configuration > Security > Firewall > Configuration**.)
- Click **Cancel** to restore the original active policy and stay on the **Active Policy** page.

## Active Rules

### Path: Configuration > Security > Firewall > Active Rules

When a firewall is enabled, this read-only page lists the individual rules that are being enforced by a current active policy. See [Create/Edit Policy](#), page 153 for descriptions of the fields (**Priority, Destination, Source, Protocol, Action, and Log**).

## Create/Edit Policy

### Path: Configuration > Security > Firewall > Create/Edit Policy

Use this page to create a new policy, or delete or edit an existing policy.

You cannot delete an active, enabled firewall policy. You can edit a running policy, but it is not recommended as changes are applied immediately. Instead, disable the firewall, edit the policy, test it, and then re-enable the policy.

## Create a new policy

Click **Add Policy**, and type in the file name for the new firewall file. The filename should have a .fwl file extension. If left without a file extension, .fwl will be appended to the name automatically.

- Click **Apply**: If the filename is legal, the empty file firewall policy file will be created. It will be located in the /fwl folder with the other policies on the system.
- Click **Cancel** to return to the previous page without creating a new firewall file.

## Edit an existing policy

Select **Edit Policy** to go to the edit page. You can edit an firewall policy which is not active.

**Warning** page: If you attempt to edit the active enabled policy, a warning page will open. **Editing the active firewall policy will cause all changes made to be applied immediately. It is recommended to disable the firewall and test the policy before enabling it.**

- Click **Apply** to leave the Warning page and return to the **Edit Policy** page.
  - Click **Cancel** to leave the Warning page and return to the **Create/Edit Policy** page.
1. Select the policy you want to edit from the **Policy Name** drop-down list, and click **Edit Policy**.
  2. Click **Add Rule** or select the **Priority** of an existing rule to go to the **Edit Rule** page. From this page, you can change the rule settings or delete the selected rule.

Setting	Description
<b>Priority</b>	If two rules conflict, the rule with the higher priority will determine what happens. The highest priority is 1; the lowest is 250.
<b>Type</b>	<b>host</b> : In the <b>IP/any</b> field, you will enter a single IP address. <b>subnet</b> : In the <b>IP/any</b> field, you will enter a subnet address. <b>range</b> : In the <b>IP/any</b> field, you will enter a range of IP addresses.
<b>IP/any</b>	Specify the IP address or range of addresses this rule applies to, or select one of the following: - <b>any</b> : The rule applies regardless of the IP address. - <b>anyipv4</b> : The rule applies for any IPv4 address. - <b>anyipv6</b> : The rule applies for any IPv6 address.
<b>Port</b>	Specify a port the rule will apply to: - <b>None</b> : The rule will apply to any port. - <b>Common Configured ports</b> : Select a standard port. - <b>Other</b> : Specify a non-standard port number.
<b>Protocol</b>	Specify which protocol the rule applies to: - <b>any</b> : any protocol. - <b>tcp</b> : used for more reliable information transfer between applications. - <b>udp</b> : alternative to TCP using for faster, lower bandwidth information. transfer. Though it has fewer delays, UDP is less reliable than TCP. - <b>icmp</b> : used to report errors for troubleshooting. - <b>icmpv6</b> : used to report errors for troubleshooting on applications using IPv6.
<b>Action</b>	<b>allow</b> : Allow the packet that matches this rule. <b>discard</b> : Discard the packet that matches this rule.
<b>Log</b>	If this rule applied to a packet, regardless of whether the packet is blocked or allowed, this will add an entry to the Firewall Log (see "Firewall log" on page 123).

It is recommended that you add one of the following as the lowest priority rule in your firewall policy:

- To use the firewall as a white list, add  
250 Dest any / Source any / protocol any / discard
- To use the firewall as a black list, add  
250 Dest any / Source any / protocol any / allow

## Delete a policy

Select **Delete Policy** to open the Confirm Deletion page.

Click **Apply** to confirm and the selected firewall file is removed from the file system.

## Load Policy

**Path: Configuration > Security > Firewall > Load Policy**

Upload a policy (with the .fwl suffix) from a source external to this device.

## Test

**Path: Configuration > Security > Firewall > Test**

Temporarily enforce the rules of a chosen policy for a time that you specify.

## 802.1X Security Configuration

**Path: Configuration > Security > 802.1X Security**

The NMC takes the role of a supplicant in an EAPoL (Extensible Authentication Protocol over LAN) architecture used in IEEE 802.1X port-based network access control. The NMC supports EAP-TLS as an authentication method which requires the user to upload 3 client-side certificates. The private key is stored in an encrypted format. The user needs to provide a valid passphrase to be able to enable 802.1X security access.

**NOTE:** The NMC supports only EAP-TLS authentication method.

The Web UI offers the following options for EAPoL configuration:

Setting	Description
<b>EAPoL Access</b>	Used to enable or disable 802.1X Security Access. <b>NOTE:</b> The 802.1X security access is disabled by default. The user can enable only when valid certificates and a valid passphrase for the private key are provided by the user.
<b>Supplicant Identifier</b>	Allows the users to set their own supplicant identifier (up to 32 characters including whitespace). <b>NOTE:</b> By default, the supplicant identifier is set to "NMC-Supplicantxx: xx:xx:xx:xx:xx:xx" where six octets of 'xx' are the MAC ID of the NMC.
<b>CA Certificate</b>	Upload/replace or remove a CA root certificate. The supported file formats are PEM (Privacy Enhanced Mail) or the DER (Distinguished Encoding Rules) format with permitted file extensions .pem, .PEM, .der, or .DER.
<b>Private Key Certificate</b>	Upload/replace or remove an encrypted private key. The supported file formats are PEM (Privacy Enhanced Mail) or the DER (Distinguished Encoding Rules) format with permitted file extensions .key or .KEY. <b>NOTE:</b> Unencrypted private key is not accepted.
<b>Private Key Passphrase</b>	Provide the passphrase to decrypt the encrypted private key. Allows up to 64 characters including whitespace.
<b>User/Public Certificate</b>	Upload/replace or remove a user/public certificate. The supported file formats are PEM (Privacy Enhanced Mail) or the DER (Distinguished Encoding Rules) format with permitted file extensions .pem, .PEM, .der, or .DER.

# Configure Network Settings

## Protocol Configuration Summary

Path: Configuration > Network > Summary

Home	Status	Control	Configuration	Tests	Logs	About
Configuration Summary						
IPv4	Enabled	<a href="#">Configure</a>				
IPv6	Enabled	<a href="#">Configure</a>				
Ping Response	Enabled	<a href="#">Configure</a>				
HTTP	Disabled	<a href="#">Configure</a>				
HTTPS	Enabled	<a href="#">Access</a>	<a href="#">SSL Certificate</a>			
FTP	Enabled	<a href="#">Configure</a>				
Telnet	Disabled	<a href="#">Configure</a>				
SSH/SCP	Enabled	<a href="#">Access</a>	<a href="#">SSH Host Key</a>			
SNMPv1	Disabled	<a href="#">Access</a>	<a href="#">Access Control</a>			
SNMPv3	Disabled	<a href="#">Access</a>	<a href="#">Access Control</a>	<a href="#">User Profiles</a>		
Super User	Enabled	<a href="#">Configure</a>				
RADIUS	Disabled	<a href="#">Authentication</a>	<a href="#">RADIUS</a>			
Administrator	Disabled	<a href="#">Configure</a>				
Device User	Disabled	<a href="#">Configure</a>				
Read-Only User	Disabled	<a href="#">Configure</a>				
Network-Only User	Disabled	<a href="#">Configure</a>				

You can use this page to view all protocols enabled or disabled on your Rack ATS. Select a link for any protocol to go to the appropriate configuration page.

## Configure TCP/IP and Communication Settings for IPv4 and IPv6

**Path: Configuration > Network > TCP/IP > IPv4**

View the current IPv4 address, subnet mask, default gateway, MAC address, and boot mode of the Rack ATS. For information on DHCP and DHCP options, see RFC2131 and RFC2132.

Setting	Description
<b>Enable</b>	Enable or disable IPv4 with this check box.
<b>Manual</b>	Configure IPv4 manually by entering the IP address, subnet mask, and default gateway.
<b>BOOTP</b>	<p>A BOOTP server provides the TCP/IP settings. At 32-second intervals, the Rack ATS requests network assignment from any BOOTP server:</p> <ul style="list-style-type: none"> <li>If the Rack ATS receives a valid response, it starts the network services.</li> <li>If the Rack ATS finds a BOOTP server, but a request to that server fails or times out, the Rack ATS stops requesting network settings until it is restarted.</li> <li>By default, if previously configured network settings exist, and the Rack ATS receives no valid response to five requests (the original and four retries), it uses the previously configured settings so that it remains accessible.</li> </ul> <p>Click <b>Next&gt;&gt;</b> to access the BOOTP Configuration page to change the number of retries or the action to take if all retries fail:</p> <ul style="list-style-type: none"> <li><b>Maximum retries:</b> Enter the number of retries that will occur when no valid response is received, or zero (0) for an unlimited number of retries.</li> <li><b>If retries fail:</b> Select <b>Use prior settings</b> (the default) or <b>Stop BOOTP</b> request.</li> </ul>
<b>DHCP</b>	<p>The default setting. At 32-second intervals, the Rack ATS requests network assignment from any DHCP server.</p> <ul style="list-style-type: none"> <li>If the Rack ATS receives a valid response, it does not (as previously) require the APC cookie from the DHCP server in order to accept the lease and start the network services.</li> <li>If the Rack ATS finds a DHCP server, but the request to that server fails or times out, it stops requesting network settings until it is restarted.</li> </ul> <p><b>Require vendor specific cookie to accept DHCP Address:</b> By selecting this check box, you can require the DHCP server to provide a cookie which supplies information to the Rack ATS.</p>
<p><b>NOTE:</b> The default values for these three settings on configuration pages generally do not need to be changed:</p> <ul style="list-style-type: none"> <li><b>Vendor Class:</b> APC</li> <li><b>Client ID:</b> The MAC address of the Rack ATS, which uniquely identifies it on the local area network (LAN)</li> <li><b>User Class:</b> The name of the application firmware module</li> </ul>	

### DHCP response options

Each valid DHCP response contains options that provide the TCP/IP settings that the Rack ATS needs to operate on a network, and other information that affects the operation of the Rack ATS.

#### Vendor Specific Information (option 43)

The Rack ATS uses this option in a DHCP response to determine whether the DHCP response is valid. This option contains an APC-specific option in a TAG/LEN/DATA format, called the APC Cookie. This is disabled by default.

- APC Cookie. Tag 1, Len 4, Data "1APC"

Option 43 communicates to the Rack ATS that a DHCP server is configured to service devices.

Following, in hexadecimal format, is an example of a Vendor Specific Information option that contains the APC cookie:

```
Option 43 = 0x01 0x04 0x31 0x41 0x50 0x43
```

## TCP/IP options

The Rack ATS uses the following options within a valid DHCP response to define its TCP/IP settings. All of these options except the first are described in RFC2132.

- **IP Address** (from the **yiaddr** field of the DHCP response, described in RFC2131): The IP address that the DHCP server is leasing to the Rack ATS.
- **Subnet Mask** (option 1): The Subnet Mask value that the Rack ATS needs to operate on the network.
- **Router**, i.e., Default Gateway (option 3): The default gateway address that the Rack ATS needs to operate on the network.
- **IP Address Lease Time** (option 51): The time duration for the lease of the IP Address to the Rack ATS.
- **Renewal Time**, T1 (option 58): The time that the Rack ATS must wait after an IP address lease is assigned before it can request a renewal of that lease.
- **Rebinding Time**, T2 (option 59): The time that the Rack ATS must wait after an IP address lease is assigned before it can seek to rebind that lease.

## Other options

The Rack ATS also uses these options within a valid DHCP response. All of these options except the last are described in RFC2132.

- **Network Time Protocol Servers** (option 42): Up to two NTP servers (primary and secondary) that the Rack ATS can use.
- **Time Offset** (option 2): The offset of the Rack ATS unit's subnet, in seconds, from Coordinated Universal Time (UTC).
- **Domain Name Server** (option 6): Up to two Domain Name System (DNS) servers (primary and secondary) that the Rack ATS can use.
- **Host Name** (option 12): The host name that the Rack ATS will use (32-character maximum length).
- **Domain Name** (option 15): The domain name that the Rack ATS will use (64-character maximum length).
- **Boot File Name** (from the file field of the DHCP response, described in RFC2131): The fully qualified directory-path to a user configuration file (.ini file) to download. The **siaddr** field of the DHCP response specifies the IP address of the server from which the Rack ATS will download the .ini file. After the download, the .ini file is used as a boot file to reconfigure the settings.

## Configure Network Port Speed

### Path: Configuration > Network > Port Speed

The **Port Speed** setting defines the communication speed of the TCP/IP port.

- For **Auto-negotiation** (the default), Ethernet devices negotiate to transmit at the highest possible speed, but if the supported speeds of two devices are unmatched, the slower speed is used.
- Alternatively, you can choose **10 Mbps** or **100 Mbps**, each with the option of **half-duplex** (communication in only one direction at a time) or **full-duplex** (communication in both directions on the same channel simultaneously).

## Configure DNS

### Path: Configuration > Network > DNS > Configuration

Use the options under **Configuration** to configure the Domain Name System (DNS):

- **Override Manual DNS Settings:** When enabled, configuration data from other sources (typically DHCP) takes precedence over the manual configurations set here.
- **Primary DNS Server or Secondary DNS Server:** Select one of these to specify the IPv4 or IPv6 addresses of the primary and optional secondary DNS server. For the Rack ATS to send e-mail, you must at least define the IP address of the primary DNS server.
  - The Rack ATS waits up to 15 seconds for a response from the primary DNS server or secondary DNS server (if specified). If the Rack ATS does not receive a response within that time, e-mail cannot be sent. Use DNS servers on the same segment as the Rack ATS or on a nearby segment (but not across a wide-area network [WAN]).
  - Define the IP addresses of the DNS servers, then enter the DNS name of a computer on your network to look up the IP address for that computer to verify correct operation.
- **System Name Synchronization:** Allow the system name to be synchronized with the host name so both fields automatically contain the same value.
 

**NOTE:** When enabling this feature, the system name identifier can no longer contain a space character (since it will be synchronized to the **Host Name** field).
- **Host Name:** Configure a host name here and a domain name in the **Domain Name** field. Users can then enter a host name in any field in the NMC interface (except e-mail addresses) that accepts a domain name.
- **Domain Name (IPv4/IPv6):** Configure the domain name here only. In all other fields in the NMC interface (except e-mail addresses) that accept domain names, the Rack ATS adds this domain name when only a host name is entered.
  - To override all instances of the expansion of a specified host name by the addition of the domain name, set the domain name field to its default, `somedomain.com`, or to `0.0.0.0`.
  - To override the expansion of a specific host name entry, include a trailing period. The NMC recognizes a host name with a trailing period (such as `mySnmpServer.`) as if it were a fullyqualified domain name and does not append the domain name.
- **Domain Name (IPv6):** Specify the IPv6 domain name here.

## Test DNS Configuration

### Path: Configuration > Network > DNS > Test

Use this option to send a DNS query that tests the setup of your DNS servers by looking up the IP address. View the result of a test in the **Last Query Response** field, or identify the value to be used for the selected query type:

Query Type Selected	Query Question to Use
by Host	The URL name of the server
by FQDN	The fully qualified domain name of the server, <code>my_server.my_domain</code>
by IP	The IP address of the server
by MX	The mail exchange address of the server

## Configure Web Access

### Path: Configuration > Network > Web > Access

To activate changes to any of these selections, all users must log off:

Setting	Description
<b>Enable HTTP</b>	Enables Hypertext Transfer Protocol (HTTP), which provides Web access by user name and password, but does not encrypt user names, passwords, and data during transmission. HTTP is disabled by default.
<b>Enable HTTPS:</b>	Enables Hypertext Transfer Protocol (HTTPS) over Secure Sockets Layer (SSL)/ Transport Layer Security (TLS). SSL and TLS encrypt user names, passwords, and data during transmission, and authenticate the Rack ATS by digital certificate. When HTTPS is enabled, your browser displays a small lock icon. For more information on HTTPS, see "Creating and Installing Digital Certificates" in the <i>Security Handbook</i> , available at <a href="http://www.se.com">www.se.com</a> . HTTPS is enabled by default.
<b>HTTP Port:</b>	The TCP/IP port (80 by default) used to communicate by HTTP with the Rack ATS.
<b>HTTPS Port</b>	The TCP/IP port (443 by default) used to communicate by HTTPS with the Rack ATS.  <b>NOTE:</b> For either port, you can change the port setting to any unused port from 5000 to 32768 for additional security. Users must then use a colon (:) in the address field of the browser to specify the port number. For example, for a port number of 5000 and an IP address of 152.214.12.114:  <code>http://152.214.12.114:5000</code>  <code>https://152.214.12.114:5000</code>
<b>Minimum Protocol</b>	Select minimum HTTPS security protocol from the drop-down list.
<b>Require Authentication cookie</b>	When the cookie is enabled, the user accessing the unit must have the correct session ID (present in the Web URL), the same remote IP address used to create the session, and the cookie present. When the cookie is disabled or has been deleted, a user can copy and paste the same URL with session ID to a new tab in the same Web browser without being required to log in.  For more information, see FAQ article FA235784: <i>Network Management Card 2 (NMC2) "Require Authentication Cookie"</i> .
<b>Limited Status Access</b>	Select <b>Enable</b> to display a public, read-only Web page with basic device status. Select <b>Use as Default Page</b> to make this status page the landing page for the Rack ATS.

**NOTE:** To find an FAQ article, go to [www.se.com](http://www.se.com), and select you location. Then select **Support > Documentation & Software Downloads** and enter the article number or title of the FAQ in the Search bar.

## Configure SSL Certificate for Web Access

**Path:** Configuration > Network > Web > SSL Certificate

View current certificate status. Add, replace, or remove a security certificate.

Setting	Description
<b>Status</b>	<ul style="list-style-type: none"> <li>• <b>Not installed:</b> A certificate is not installed, or was installed by FTP or SCP to an incorrect location. Using <b>Add or Replace Certificate File</b> installs the certificate to the correct location, /ssl on the Rack ATS.</li> <li>• <b>Generating:</b> The Rack ATS is generating a certificate because no valid certificate was found.</li> <li>• <b>Loading:</b> A certificate is being activated on the Rack ATS.</li> <li>• <b>Valid certificate:</b> A valid certificate was installed or was generated by the Rack ATS. Select this link to view the contents of the certificate.</li> </ul> <p><b>NOTE:</b> If you install an invalid certificate, or if no certificate is loaded when you enable SSL/TLS, the Rack ATS generates a default certificate, a process which delays access to the interface for up to one minute. You can use the default certificate for basic encryption-based security measures, but a security alert message displays whenever you log on.</p>
<b>Certificate Action:</b>	<ul style="list-style-type: none"> <li>• <b>Add or Replace:</b> Enter or browse to the certificate file created with the Security Wizard. See "Creating and Installing Digital Certificates" in the <i>Security Handbook</i>, available at <a href="http://www.se.com">www.se.com</a>, to choose a method for using digital certificates created by the Security Wizard or generated by the Rack ATS.</li> <li>• <b>Remove:</b> Delete the current certificate.</li> </ul>

## Configure CLI Access

**Path:** Configuration > Network > Console > Access

**Enable Telnet:** Telnet transmits user names, passwords, and data without encryption. Telnet is disabled by default.

**Enable SSH:** SSH transmits user names, passwords, and data in encrypted form, which helps to protect against attempts to intercept, forge, or alter data during transmission. SSH is enabled by default.

**Telnet Port:** The Telnet port (23 by default) is used to communicate with the Rack ATS. You can change the port setting to any unused port from 5000 to 32768 for additional security. Users must then use a colon (:) or a space, as required by your Telnet client program, to specify the non-default port. For example, for port 5000 and an IP address of 152.214.12.114, your Telnet client requires one of the these commands:

```
telnet 152.214.12.114:5000
```

```
telnet 152.214.12.114 5000
```

**SSH Port:** The SSH port (22 by default) is used to communicate with the Rack ATS. You can change the port setting to any unused port from 5000 to 32768 for additional security. See the documentation for your SSH client for the command line format required to specify a non-default port.

## Configure SSH Host Key

**Path:** Configuration > Network > Console > SSH Host Key

**Status** indicates the status of the host key (private key):

- **SSH Disabled: No host key in use:** When disabled, SSH cannot use a host key.
- **Generating:** The Rack ATS is creating a host key because no valid host key was found.
- **Loading:** A host key is being activated on the Rack ATS.
- **Valid:** One of the following valid host keys is in the `/ssh` directory (the required location on the Rack ATS):
  - A 1024-bit or 2048-bit host key created by the Security Wizard
  - A 2048-bit RSA host key generated by the Rack ATS

**Certificate Action:**

- **Add or Replace:** Browse to and upload a host key file created by the Security Wizard. To use the Security Wizard, see the *Security Handbook*, available at [www.se.com](http://www.se.com).

**NOTE:** To reduce the time required to enable SSH, create and upload a host key in advance. If you enable SSH with no host key loaded, the Rack ATS takes up to one minute to create a host key, and the SSH server is not accessible during that time.

- **Host Key Fingerprint:** A fingerprint helps authenticate a server. If the Security Wizard is used to generate the host key, it also generates the fingerprint, which is displayed here when SSH is enabled and the host key is in use. When you first connect to the device using SSH, compare the fingerprint presented by the SSH client to the fingerprint that the Security Wizard generated to ensure that they match. (Almost all SSH clients display the fingerprint.)
- **Remove:** Remove the current host key.

**NOTE:** To use SSH, you must have an SSH client installed. Most Linux and other UNIX platforms include an SSH client, but Microsoft Windows operating systems do not. Clients are available from various vendors.

## SNMP Options

All user names, passwords, and community names for SNMPv1 are transferred over the network as plain text. If your network requires the high security of encryption, disable SNMPv1 access and use SNMPv3 instead.

When using Data Center Expert to manage a Rack ATS on the public network, you must have the same version of SNMP (1 or 3) enabled on both the Rack ATS interface and the Data Center Expert interface. Read access will allow the Data Center Expert to receive traps from the Rack ATS, but Write access is required while you set the Data Center Expert as a trap receiver.

For detailed information on enhancing and managing the security of your system, see the *Security Handbook*, available at [www.se.com](http://www.se.com).

## Network Port Sharing

All Rack ATS units in a group can be accessed through the Host Rack ATS via SNMP "ats5g" OIDs available in our PowerNet-MIB.

The full path to these OIDs is: iso(1).org(3).dod(6).internet(1).private(4).enterprises(1).apc(318).products(1).hardware(1).ats5g(33)

Individual Rack ATS units can be identified in the SNMP MIB tables by viewing the corresponding "Module" OIDs in each table. These Module OIDs will return the Display ID of the Rack ATS.

Example Module OIDs: ats5gIdentConfigModuleID, ats5gSwitchModuleID, ats5gEnvModuleID, ats5gBankModuleID

In order to be backwards compatible with previous versions, the Host Rack ATS will always be the first index in any table that supports multiple Rack ATS units. In addition, after the Rack ATS group is set up, the index order of guest Rack ATS units should not change even if the Display ID is changed or a unit temporarily loses communication. The index order should only change if you manually remove a Rack ATS from the group.

An MIB table walk should skip the indexes associated with a Rack ATS that has temporarily lost communication.

## SNMPv1

SNMPv1 is disabled by default. SNMPv2c is supported under SNMPv1 in this configuration.

### Access

**Path:** Configuration > Network > SNMPv1 > Access

**Enable SNMPv1 Access:** Enables SNMP version 1 as a method of communication with this device.

### Access Control

**Path:** Configuration > Network > SNMPv1 > Access Control

You can configure up to four access control entries to specify which Network Management Systems (NMSs) have access to this device. The opening page for access control, by default, assigns one entry to each of the four available SNMPv1 communities, but you can edit these settings to apply more than one entry to any community to grant access by several specific IPv4 and IPv6 addresses, host names, or IP address masks. To edit the access control settings for a community, select its community name.

**NOTE:** If you leave the default access control entry unchanged for a community, that community has access to this device from any location on the network.

**NOTE:** If you configure multiple access control entries for one community name, the limit of four entries requires that one or more of the other communities must have no access control entry. If no access control entry is listed for a community, that community has no access to this device.

Setting	Description
<b>Community Name</b>	The name that an NMS must use to access the community. The maximum length is 16 ASCII characters.
<b>NMS IP/ Host Name</b>	The IPv4 or IPv6 address, IP address mask, or host name that controls access by NMSs. A host name or a specific IP address (such as 149.225.12.1) allows access only by the NMS at that location. IP addresses that contain 255 restrict access as follows: <ul style="list-style-type: none"> <li>- 149.225.12.<b>255</b>: Access only by an NMS on the 149.225.12 segment.</li> <li>- 149.225.<b>255.255</b>: Access only by an NMS on the 149.225 segment.</li> <li>- 149.<b>255.255.255</b>: Access only by an NMS on the 149 segment.</li> <li>- 0.0.0.0 (the default) or 255.255.255.255: Access by any NMS on any segment.</li> </ul>
<b>Access Type</b>	The actions an NMS can perform through the community. <ul style="list-style-type: none"> <li>- <b>Read</b>: GETs only, at any time</li> <li>- <b>Write</b>: GETs at any time, and SETs when no user is logged onto the Web UI or CLI.</li> <li>- <b>Write+</b>: GETs and SETs at any time.</li> <li>- <b>Disable</b>: No GETs or SETs at any time.</li> </ul>

## SNMPv3

SNMPv3 is disabled by default.

For SNMP GETs, SETs, and trap receivers, SNMPv3 uses a system of user profiles to identify users. An SNMPv3 user must have a user profile assigned in the MIB software program to perform GETs and SETs, browse the MIB, and receive traps.

**NOTE:** To use SNMPv3, you must have an MIB program that supports SNMPv3.

## Access

**Path:** Configuration > Network > SNMPv3 > Access

**SNMPv3 Access:** Enables SNMPv3 as a method of communication with this device.

## User Profiles

**Path:** Configuration > Network > SNMPv3 > User Profiles

By default, this page lists the settings of four user profiles configured with the user names **apc snmp profile1** through **apc snmp profile4**, and no authentication or privacy (no encryption). To edit the following settings for a user profile, select a user name in the list.

Setting	Description
<b>User Name</b>	The identifier of the user profile. SNMPv3 maps GETs, SETs, and traps to a user profile by matching the user name of the profile to the user name in the data packet being transmitted. A user name can have up to 32 ASCII characters.
<b>Authentication Passphrase</b>	A phrase of 15 to 32 ASCII characters that verifies that the NMS communicating with this device through SNMPv3 is the NMS it claims to be, that the message has not been changed during transmission, and that the message was communicated in a timely manner, indicating that it was not delayed and that it was not copied and sent again later at an inappropriate time.
<b>Privacy Passphrase</b>	A phrase of 15 to 32 ASCII characters ( <code>hidden crypt .phrase</code> , by default) that increases the privacy of the data (by means of encryption) that an NMS is sending to this device or receiving from this device through SNMPv3.
<b>Authentication Protocol</b>	The Schneider Electric implementation of SNMPv3 supports SHA or MD5 authentication. Authentication will not occur unless an authentication protocol is selected.
<b>Privacy Protocol</b>	The implementation of SNMPv3 supports AES or DES as the protocols for encrypting and decrypting data. Privacy of transmitted data requires that a privacy protocol is selected and that a privacy passphrase is provided in the request from the NMS. When a privacy protocol is enabled but the NMS does not provide a privacy passphrase, the SNMP request is not encrypted. <b>NOTE:</b> You cannot select the privacy protocol if no authentication protocol is selected.

## Access Control

### Path: Configuration > Network > SNMPv3 > Access Control

You can configure up to four access control entries to specify which Network Management Systems (NMSs) have access to this device. The opening page for access control, by default, assigns one entry to each of the four user profiles, but you can edit these settings to apply more than one entry to any user profile to grant access by several specific IP addresses, host names, or IP address masks.

**NOTE:** If you leave the default access control entry unchanged for a user profile, all Network Management Systems using that profile have access to this device.

**NOTE:** If you configure multiple access entries for one user profile, the limit of four entries requires that one or more of the other user profiles must have no access control entry. If no access control entry is listed for a user profile, no NMS that uses that profile has any access to this device.

To edit the access control settings for a user profile, select its user name.

Setting	Description
<b>Access</b>	Select <b>Enable</b> to activate the access control specified by the parameters in this access control entry.
<b>User Name</b>	Select the user profile to which this access control entry will apply. The choices available are the four user names that you configure on the user profiles page (under <b>Configuration &gt; Network &gt; SNMPv3 &gt; User Profiles</b> ).
<b>NMS IP/ Host Name</b>	The IP address, IP address mask, or host name that controls access by the NMS. A host name or a specific IP address (such as 149.225.12.1) allows access only by the NMS at that location. An IP address mask that contains 255 restricts access as follows: <ul style="list-style-type: none"> <li>- 149.225.12.<b>255</b>: Access only by an NMS on the 149.225.12 segment.</li> <li>- 149.225.<b>255.255</b>: Access only by an NMS on the 149.225 segment.</li> <li>- 149.<b>255.255.255</b>: Access only by an NMS on the 149 segment.</li> <li>- 0.0.0.0 (the default) or 255.255.255.255: Access by any NMS on any segment.</li> </ul>

## Enable Modbus TCP

### Path: Configuration > Network > TCP

Enable Modbus to allow a Building Management System to monitor the Rack ATS device through Modbus TCP.

#### Configuration

**Modbus TCP**

**Access**  
 Enable

**Port** [ 502, 5000 to 32768]

**Communication Timeout**  
 Never  
 Time  
(secs) [0 to 64800, 0 - never]

**Keep-Alive**  
 Enable

To enable Modbus TCP,

Setting	Description
<b>Access</b>	Select <b>Enable</b> to enable Modbus TCP.
<b>Port</b>	Specify the port for the TCP connection (502 by default, or 5000 to 32768).
<b>Communication Timeout:</b>	Enter the number of seconds the Rack ATS device waits before disconnecting from the Modbus Poll software.
<b>Keep-Alive</b>	When you select <b>Enable</b> , the Rack ATS device sends a packet to the server every two hours and 75 seconds, if there is no other communication detected. This helps prevent a communication timeout when Communication Timeout is set to 7,275 seconds or more.

You must reboot the Rack ATS log off for the changes to take effect.

## Configure FTP Server

### Path: Configuration > Network > FTP Server

The FTP Server settings enable or disable access to the FTP server. FTP is disabled by default.

By default, the FTP server communicates with the Rack ATS through TCP/IP port 21. The FTP server uses both the specified port and the port one number lower than the specified port.

You can change the **Port** setting to the number of any unused port from 5001 to 32768 for added security. Users must then use a colon (:) to specify the non-default port number.

For example, for port 5001 and IP address 152.214.12.114, the command would be `ftp 152.214.12.114:5001`.

**NOTE:** FTP transfers files without encryption. For higher security, transfer files with Secure CoPy (SCP). Secure SHell (*SSH*) is enabled by default, and enables SCP automatically. However, SCP will not allow a file transfer until the Super User default password (**apc**) is changed. At any time that you want a Rack ATS to be accessible for management by Data Center Expert, FTP server access must be enabled in the Rack ATS interface.

**NOTE:** You can use FTP or SCP to configure and update the Rack ATS with Data Center Expert or EcoStruxure IT as long as the same protocol is enabled on both the Rack ATS and Data Center Expert or EcoStruxure IT. See your Data Center Expert or EcoStruxure IT documentation for details.

For detailed information on enhancing and managing the security of your system, see the *Security Handbook*, available at [www.se.com](http://www.se.com).

## Wi-Fi Configuration with AP9834

**Path: Configuration > Network > Wi-Fi**

Reserved for future use.

## Configure Notifications

You can configure event actions to occur in response to an event or group of events. These actions notify users of the event in any of several ways:

- Active, automatic notification. The specified users or monitoring devices are contacted directly.
  - E-mail notification
  - SNMP traps
  - Syslog notification
- Indirect notification
  - Event log. If no direct notification is configured, users must check the log to determine which events have occurred.

You can also log system performance data to use for device monitoring. See [Configure Logs](#), page 177 for information on how to configure and use this data logging option.

- Queries (SNMP GETs).

SNMP enables an NMS to perform informational queries. For SNMPv1, which does not encrypt data before transmission, configuring the most restrictive SNMP access type (READ) enables informational queries without the risk of allowing remote configuration changes. You can configure the access type under

For more information on SNMP, see [SNMP Options](#), page 163.

## Configure Notifications By Event

**Path: Configuration > Notification > Event Actions > By Event**

By default, logging an event is selected for all events. To define event actions for an individual event:

1. Select an event category or sub-category to see the related event lists.
2. Select an event name to view the current configuration, such as recipients to be notified by email, or Network Management Systems (NMSs) to be notified by SNMP traps. If no Syslog server is configured, items related to Syslog configuration are not displayed. You can also disable event logging or Syslog, or disable notification for specific e-mail recipients or trap receivers.

**NOTE:** When viewing details of an event configuration, you cannot add or remove recipients or receivers. To add or remove recipients or receivers, see the following sections:

- [Identify Syslog Servers](#), page 177
- [Recipients](#), page 172
- [Configure Trap Receivers](#), page 173

## Configure Notifications By Group

### Path: Configuration > Notification > Event Actions > By Group

To configure a group of events simultaneously:

1. Select how to group events for configuration:
  - You can select events by **Severity**, and then select one or more severity levels. You cannot change the severity of an event.
  - You can select events by **Category**, and then select events in one or more pre-defined categories.
2. Click **Next** to select an event action.
 

To select any action except **Logging** (the default), you must first have at least one relevant recipient or receiver configured.
3. Click **Next** to do one of the following:
  - If you selected **Logging** on the previous screen and have not configured a Syslog server, select **Configure Event Log**.
  - If you selected **Logging** on the previous screen and have configured a Syslog server, select **Event Log** or **Syslog**.
  - If you selected **Email Recipients** on the previous screen, select the e-mail recipients to configure.
  - If you selected **Trap Receivers** on the previous screen, select the trap receiver to configure.
4. Click **Next** to configure notification parameters. These configuration fields define e-mail parameters to send notifications:
  - If you are configuring **Logging** settings, select **Enable Notification** or **Disable Notification**.
  - If you are configuring **Email Recipients** or **Trap Receivers**, select **Enable Notification** or **Disable Notification** and set the notification parameters.
5. Click **Next** to view pending actions and do one of the following:
  - Click **Apply** to accept the changes.
  - Click **Cancel** to revert to the previous settings.

**Email Notification Parameters:** These configuration fields define e-mail parameters for sending notifications of events. You can access notification parameters by selecting the receiver or recipient name.

Field	Description
<b>Delay n time before sending</b>	If the event persists for the specified time, the notification is sent. If the condition clears before the time expires, no notification is sent.
<b>Repeat at an interval of n</b>	The notification is sent repeatedly at the specified interval (the default is every two minutes until the condition clears).
<b>Up to n times</b> or <b>Until condition clears</b>	During an active event, the notification repeats for this number of times.  The notification is sent repeatedly until the condition clears or is resolved.

**NOTE:** You can also set notification parameters for events that have an associated clearing event.

## Set Up E-mail Notifications

Use Simple Mail Transfer Protocol (SMTP) to send e-mail to up to four recipients when an event occurs. To use the e-mail feature, you must define the following settings:

- The IP addresses of the primary and, optionally, the secondary Domain Name System (DNS) servers.
- The IP address or DNS name for the SMTP Server and From Address.
- The e-mail addresses for a maximum of four recipients.
- You can use the **To Address** setting of the **Recipients** option to send e-mail to a text-based screen.

## Server

**Path: Configuration > Notification > E-mail > Server**

This screen lists your primary and secondary DNS servers and displays the following fields:

Select **Active Primary DNS Server** or **Active Secondary DNS Server** to configure the DNS Servers (from the **Configuration > Network > DNS > Configuration**) page.

Setting	Description
<b>From Address</b>	<p>The contents of the From field in e-mail messages sent by the Rack ATS.</p> <ul style="list-style-type: none"> <li>• Use the format <i>user@[IP_address]</i> if an IP address is specified as Local SMTP Server.</li> <li>• Use the format <i>user@domain</i> if DNS is configured and the DNS name is specified as Local SMTP Server.</li> </ul> <p><b>NOTE:</b> The local SMTP server may require that you use a valid user account on the server for this setting. Check the server documentation.</p>
<b>SMTP Server</b>	<p>The IPv4/ IPv6 address or DNS name of the local SMTP server.</p> <p><b>NOTE:</b> This definition is required only when the SMTP server is set to <b>Local</b>.</p>
<b>Port</b>	<p>The SMTP port number, with a default of 25. Supported ports include 25, 465, 587, 2525, and 5000 to 32768.</p>
<b>Authentication</b>	<p>Select <b>Enable</b> if the SMTP server requires authentication.</p> <p><b>User Name, Password, and Confirm Password:</b> If your mail server requires authentication, enter your user name and password here. This performs a simple authentication, not SSL/TLS.</p>
<b>Use SSL/TLS</b>	<p>Select when encryption is used.</p> <ul style="list-style-type: none"> <li>• <b>Never:</b> The SMTP server does neither requires nor supports encryption.</li> <li>• <b>If Supported:</b> The SMTP server advertises support for STARTTLS but doesn't require the connection to be encrypted. The STARTTLS command is sent after the advertisement is given.</li> <li>• <b>Always:</b> The SMTP server requires the STARTTLS command to be sent on connection to it.</li> <li>• <b>Implicitly:</b> The SMTP server only accepts connections that begin encrypted. No STARTTLS message is sent to the server.</li> </ul>
<b>Require CA Root Certificate</b>	<p>This should only be enabled if the security policy of your organization does not allow for implicit trust of SSL/TLS connections. If this is enabled, a valid root CA certificate must be loaded onto the Rack ATS for encrypted e-mails to be sent.</p>
<b>File Name</b>	<p>This field is dependent on the root CA certificates installed on the Rack ATS and whether or not a root CA certificate is required.</p>

## Recipients

### Path: Configuration > Notification > E-mail > Recipients

Specify up to four e-mail recipients. Click **Add Recipient**, or select a name to configure the settings.

Setting	Description
<b>E-mail Recipient</b>	
<b>Generation</b>	Enable (default) or disable sending e-mail to the recipient.
<b>To Address</b>	<p>The user name and domain name of the recipient. To use e-mail for paging, use the e-mail address for the recipient's pager gateway account (for example, myacct100@skytel.com). The pager gateway will generate the page.</p> <p>To bypass the DNS lookup of the IP address of the mail server, type the IP address in brackets instead of the e-mail domain name, e.g., use jsmith@[xxx.xxx.x.xxx] instead of jsmith@company.com. This is useful when DNS lookups are not working correctly.</p>
<b>Format</b>	The <b>Long</b> format contains name, location, contact, IP address, serial number of the device, date and time, event code, and event description. The <b>Short</b> format provides only the event description.
<b>Language:</b>	The language the e-mail notification will be sent in. This depends on the installed language pack (if applicable).
<b>Server</b>	<p>Select one of the following methods for routing e-mail:</p> <ul style="list-style-type: none"> <li>• <b>Local:</b> This is through the site-local SMTP server. This recommended setting uses a site-local SMTP server to send e-mail. Choosing this setting limits delays and network outages and retries sending e-mail for many hours. When choosing the Local setting you must also enable forwarding at the SMTP server of your device and set up a special external e-mail account to receive the forwarded e-mail. Check with your SMTP server administrator before making these changes.</li> <li>• <b>Recipient:</b> This is the SMTP server of the recipient. The Rack ATS performs an MX record look-up on the recipients e-mail address and uses that as its SMTP server. The e-mail is only sent once so it could easily be lost.</li> <li>• <b>Custom:</b> This setting enables each e-mail recipient to have its own server settings. These settings are independent of the local SMTP server settings (configured under <b>Configuration &gt; Notification &gt; E-mail &gt; Server</b>).</li> </ul>
<b>Custom E-mail server Settings</b>	
<b>From Address:</b>	<p>The contents of the From field in e-mail messages sent by the Rack ATS:</p> <ul style="list-style-type: none"> <li>• In the format user@[IP_address] (if an IP address is specified as Local SMTP Server)</li> <li>• In the format user@domain (if DNS is configured and the DNS name is specified as Local SMTP Server) in the e-mail messages.</li> </ul> <p><b>NOTE:</b> The local SMTP server may require that you use a valid user account on the server for this setting. See the server documentation.</p>
<b>SMTP Server:</b>	<p>The IPv4/ IPv6 address or DNS name of the local SMTP server.</p> <p><b>NOTE:</b> This definition is required only when the SMTP server is set to <b>Local</b>.</p>
<b>Port</b>	The SMTP port number, with a default of 25. Supported ports include 25, 465, 587, 2525, and 5000 to 32768.
<b>Authentication</b>	Enable this if the SMTP server requires authentication.
<b>User Name, Password, and Confirm Password</b>	If your mail server requires authentication, enter your user name and password here. This performs a simple authentication, not SSL/TLS.
<b>Advanced</b>	
<b>Use SSL/TLS</b>	<p>Select when encryption is used.</p> <ul style="list-style-type: none"> <li>• <b>Never:</b> The SMTP server does not require nor support encryption.</li> <li>• <b>If Supported:</b> The SMTP server advertises support for STARTTLS but doesn't require the connection to be encrypted. The STARTTLS command is sent after the advertisement is given.</li> <li>• <b>Always:</b> The SMTP server requires the STARTTLS command to be sent on connection to it.</li> <li>• <b>Implicitly:</b> The SMTP server only accepts connections that begin encrypted. No STARTTLS message is sent to the server.</li> </ul>
<b>Require CA Root Certificate</b>	This should only be enabled if the security policy of your organization does not allow for implicit trust of SSL/TLS connections. If this is enabled, a valid root CA certificate must be loaded onto the Rack ATS for encrypted e-mails to be sent.
<b>File Name</b>	This field is dependent on the root CA certificates installed on the Rack ATS and whether or not a root CA certificate is required.

## SSL Certificates

### Path: Configuration > Notification > E-mail > SSL Certificates

Load a mail SSL/TLS certificate on the Rack ATS for greater security. The file must have an extension of `.crt` or `.cer`. Up to five files can be loaded at any given time.

When installed, the certificate details also display here. An invalid certificate will display “n/a” for all fields except **File Name**.

Certificates can be deleted using this screen. Any e-mail recipients using the certificate should be manually modified to remove reference to this certificate.

## Test

### Path: Configuration > Notification > E-mail > Test

Send a test message to a configured recipient.

## SNMP Traps

With Simple Network Management Protocol (SNMP) traps, you can automatically get notifications for significant Rack ATS events. They are a useful tool for monitoring devices on your network.

## Configure Trap Receivers

### Path: Configuration > Notification > SNMP Traps > Trap Receivers

The trap receivers are displayed by **NMS IP/Host Name**, (NMS stands for Network Management System). You can configure up to six trap receivers. To configure a new trap receiver, click **Add Trap Receiver**. To edit (or delete) a trap receiver, select its IP address/host name.

**Trap Generation:** Enable (the default) or disable trap generation for this trap receiver.

**NMS IP/Host Name:** The IPv4/ IPv6 address or host name of this trap receiver. The default, 0.0.0.0, leaves the trap receiver undefined.

**Language:** Select a language from the drop-down list. This can differ from the Web UI and from other trap receivers.

Select either **SNMPv1** or **SNMPv3** to specify the trap type. For an NMS to receive both types of traps, you must separately configure two trap receivers for that NMS, one for each trap type.

**SNMPv1:** Settings for SNMPv1.

- **Community Name:** The name used as an identifier when SNMPv1 traps are sent to this trap receiver.
- **Authenticate Traps:** When this option is enabled (the default), the NMS identified by the NMS IP/ Host Name setting will receive authentication traps (traps generated by invalid attempts to log on to this device).

**SNMPv3:** Settings for SNMPv3.

- **User Name:** Select the identifier of the user profile for this trap receiver.

If you delete a trap receiver, all notification settings configured under “Configuring event actions” for the deleted trap receiver are set to their default values.

## Test SNMP Traps

**Path:** Configuration > Notification > SNMP Traps > Test

**Last Test Result:** The result of the most recent SNMP trap test. A successful SNMP trap test verifies only that a trap was sent; it does not verify that the trap was received by the selected trap receiver. A trap test succeeds if all of the following are true:

- The SNMP version (SNMPv1 or SNMPv3) configured for the selected trap receiver is enabled on this device.
- The trap receiver itself is enabled.
- If a host name is selected for the **To** address, that host name can be mapped to an valid IP address.

**To** Select the IP address or host name to which a test SNMP trap will be sent. If no trap receiver is configured, a link to the **Trap Receiver** configuration screen (**snmp receiver**) is displayed.

## General Configuration

This menu contains miscellaneous configuration items including device identification, date and time, exporting and importing your Rack ATS configuration options, quick links, and data consolidation for troubleshooting.

## Configure identification

**Path:** Configuration > General > Identification

**Host Name Synchronization:** Allows the host name to be synchronized with the system name so both fields automatically contain the same value.

**NOTE:** When enabling this feature, the system name identifier can no longer contain a space character (since it will be synchronized to the host name field).

**Name, Contact, and Location:** Define the **Name**, the **Contact** (the person responsible for the device), and the **Location** (the physical location), used by the SNMP agent of the Rack ATS and Data Center Expert.

These fields are used by the **sysName**, **sysContact**, and **sysLocation** object identifiers (OIDs) in the SNMP agent of the Rack ATS. For more information about MIB-II OIDs, see the PowerNet® *SNMP Management Information Base (MIB) Reference Guide*, available at [www.se.com](http://www.se.com).

The **Name** and **Location** fields also identify the device when you register for the Remote Monitoring Service.

**System Message:** When defined, a custom message will appear on the log on screen for all users.

## Configure Date, Time, and Daylight Savings

### Path: Configuration > General > Date/Time > Mode

Set the time and date used by the Rack ATS. You can change the current settings manually or through a Network Time Protocol (NTP) Server:

**Time Zone:** This is your local time difference with Coordinated Universal Time (UTC), also known as Greenwich Mean Time (GMT).

**Manual Mode:** Do one of the following:

- Enter the date and time for the Rack ATS.
- Select the **Apply Local Computer Time** check box to apply the date and time settings of the computer you are using.

**Synchronize with NTP Server:** Have an NTP (Network Time Protocol) Server define the date and time for the Rack ATS. By default, any Rack ATS on the private side of Data Center Expert Server obtains its time settings by using Data Center Expert as an NTP server.

- **Override Manual NTP Settings:** If you select this, data from other sources (typically DHCP) take precedence over the NTP configurations you set here.
- **Primary NTP Server:** Enter the IP address or domain name of the primary NTP server.
- **Secondary NTP Server:** Enter the IP address or domain name of the secondary NTP server, when a secondary server is available.
- **Update Interval:** Define, in hours, how often the Rack ATS accesses the NTP Server for an update. Minimum: 1; Maximum: 8760 (1 year).
- **Update Using NTP Now:** Initiate an immediate update of the date and time by the NTP Server.

## Daylight Saving

### Path: Configuration > General > Date /Time > Daylight Saving

Daylight Saving Time (DST) is disabled by default. You can enable traditional United States DST, or enable and configure a customized daylight saving time to match how Daylight Saving Time is implemented in your local area.

When customizing DST, the system puts the clock forward by an hour when the time and date you specify under **Start** is reached, and puts the clock back an hour when the time and date you specify under **End** is reached.

- If your local DST always starts or ends on the fourth occurrence of a specific weekday of a month (e.g., the fourth Sunday), choose Fourth/Last. If a fifth Sunday occurs in that month, you should still choose Fourth/Last.
- If your local DST always starts or ends on the last occurrence of a specific weekday of a month, whether it is the fourth or the fifth occurrence, choose Fifth/Last.

## Create and Import Settings with the Config File

### Path: Configuration > General > User Config File

Use the settings from one Rack ATS to configure another. Retrieve the configuration file (*config.ini*) from the configured Rack ATS, customize that file (e.g., change the IP address), and upload the customized file to the new Rack ATS. The file name can be up to 64 characters, and must have the .ini suffix.

<b>Status</b>	<p>Reports the progress of the upload.</p> <ul style="list-style-type: none"> <li>• <b>No configuration file uploaded:</b> The Rack ATS has not been configured with a <i>config.ini</i> file.</li> <li>• <b>Configuration file successfully uploaded:</b> The Rack ATS has been configured with a <i>config.ini</i> file. You may need to refresh the page to see this message.</li> </ul> <p><b>NOTE:</b> The upload succeeds even if the file contains errors, but a system event reports the errors in the Event Log.</p>
<b>Upload</b>	Browse to the customized file and upload it so that the current Rack ATS can use it to set its own configuration.
<b>Download</b>	Allows the download of the <i>config.ini</i> file directly through the Web browser to your computer.

Instead of uploading the file to one Rack ATS, you can export the file to multiple Rack ATS units by using an FTP or SCP script.

**NOTE:** To retrieve and customize the file of a configured Rack ATS, see [How to Export Configuration Settings](#), page 189.

## Configure Quick Links

### Path: Configuration > General > Quick Links

View and change the URL links displayed at the lower-left of each page of the interface.

By default, these links access the following Web pages:

- Link 1: The home page of APC website
- Link 2: Information on EcoStruxure™ IT
- Link 3: Additional information on IT Power Distribution equipment

## Configure Logs

### Identify Syslog Servers

**Path:** Configuration > Logs > Syslog > Servers

Click **Add Server** to configure a new Syslog server.

**Syslog Server:** Uses IPv4/ IPv6 addresses or host names to identify from one to four servers to receive Syslog messages sent by the Rack ATS.

**Port:** The port that the Rack ATS will use to send Syslog messages. The default UDP port assigned to Syslog is 514.

**Language:** Select the language for any Syslog messages. (Only English is available at this time.)

**Protocol:** Select either UDP or TCP.

Click **Apply** to save or **Cancel** to leave without saving.

### Configure Syslog Settings

**Path:** Configuration > Logs > Syslog > Settings

**Message Generation:** Enable the generation and the logging of Syslog messages for events that have Syslog configured as a notification method.

**Facility Code:** Selects the facility code assigned to the Syslog messages of the Rack ATS (User, by default).

**NOTE:** **User** best defines the Syslog messages sent by the Rack ATS. Do not change this selection unless advised to do so by the Syslog network or system administrator.

**Severity Mapping:** This section maps each severity level of the Rack ATS or environment events to available Syslog priorities. The local options are **Critical**, **Warning**, and **Informational**. You should not need to change the mappings.

- **Emergency:** The system is unusable
- **Alert:** Action must be taken immediately
- **Critical:** Critical conditions
- **Error:** Error conditions
- **Warning:** Warning conditions
- **Notice:** Normal but significant conditions
- **Info:** Informational messages
- **Debug:** Debug-level messages

The following are the default settings for **Local Priority**:

- **Critical** is mapped to **Critical**
- **Warning** is mapped to **Warning**
- **Informational** is mapped to **Info**

---

## Test Syslog Servers

### Path: Configuration > Logs > Syslog > Test

Send a test message to the Syslog servers (configured through the “Syslog servers” page). The result will be sent to all configured Syslog servers.

Select a severity to assign to the test message and then define the test message. Format the message to consist of the event type (for example, APC, System, or Device) followed by a colon, a space, and the event text. The message can have a maximum of 50 characters.

- The priority (PRI): the Syslog priority assigned to the message event, and the facility code of messages sent by the Rack ATS.
- The Header: a time stamp and the IP address of the Rack ATS.
- The message (MSG) part.
  - The **TAG** field, followed by a colon and space, identifies the event type.
  - The **CONTENT** field is the event text, followed (optionally) by a space and the event code.

Example: APC: Test Syslog is valid.

## Tests Tab

### Set the LCD Light to Blink

**Path: Tests > ATS > LCD Blink**

If you are having trouble finding your Rack ATS, enter a number of minutes in the **LCD Blink Duration** field, and click **Apply**. The LCD display will blink for the specified number of minutes.

### Set the LED Light to Blink

**Path: Tests > Network > LED Blink**

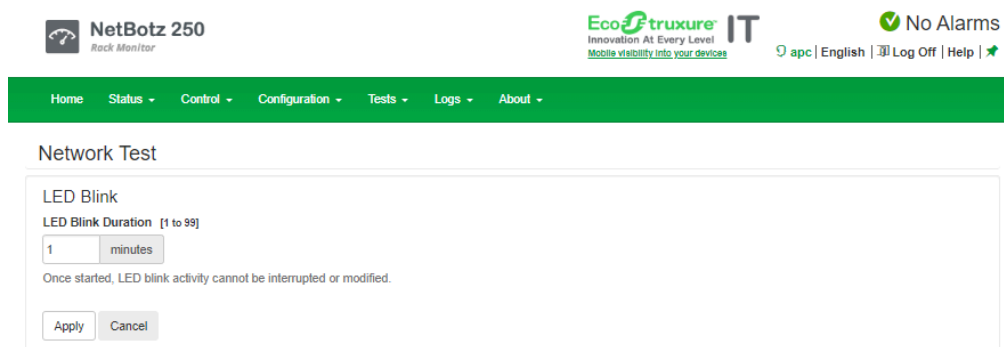

The screenshot shows the NetBotz 250 Rack Monitor web interface. The top navigation bar is green and contains the following items: Home, Status, Control, Configuration, Tests, Logs, and About. The main content area is titled "Network Test" and contains a form for "LED Blink". The form has a field for "LED Blink Duration [1 to 99]" with a value of "1" and the unit "minutes". Below the field is a note: "Once started, LED blink activity cannot be interrupted or modified." At the bottom of the form are two buttons: "Apply" and "Cancel".

If you are having trouble finding your Rack ATS, enter a number of minutes in the **LED Blink Duration** field, and click **Apply**. The 10/100/1000 Status LED light on the display will blink for the specified number of minutes.

# Logs Tab

## View and Configure the Event Log

By default, the Event Log displays all events recorded during the last two days, starting with the latest events.

Additionally, the log records any event that sends an SNMP trap, except SNMP authentication failures, and abnormal internal system events.

You can enable color coding for events on the **Local User Management** screen (under **Configuration > Security > Local Users > Management**).

## Viewing the Event Log

Path: **Logs > Events > Log**

Event Log Filtering

Event Time

Last

2 days

From

10/08/2022 11:05 to 10/10/2022 11:05

Apply Clear Log Filter Log Launch Log in New Window

Event Log

Date	Time	User	Event
10/10/2022	11:05:02	apc	Configuration change. Event log web display time selection.
10/10/2022	11:04:53	apc	Configuration change. Event log web display time selection.
10/10/2022	11:04:47	apc	Configuration change. Event log web display time selection.
10/10/2022	11:04:43	apc	Configuration change. Event log web display time selection.
10/10/2022	11:04:35	apc	Configuration change. Event log web display time selection.
10/10/2022	10:55:21	apc	Web user 'apc' logged in from 10.252.80.231.
10/10/2022	10:23:01	System	Web user 'apc' logged out from 10.252.80.231.
10/10/2022	09:23:00	apc	Web user 'apc' logged in from 10.252.80.231.

To open the log in a text file or to save the log to a disk, click on the floppy disk  on the same line as the **Event Log** heading.

To see the events listed together on a Web page, click **Launch Log in New Window**.

You can also use FTP or Secure CoPy (SCP) to view the Event Log. See [Use FTP or SCP to Retrieve Log Files](#), page 185.

**Event Log Filtering:** Use filtering to omit information you don't want to display.

- To filter the log by date or time: Use **Last** or **From** to define the time in which the events were logged. (The filter configuration is saved until the Rack ATS restarts.)

- To filter the log by event severity or category:
  1. Click **Filter Log**.
  2. Clear a check box to remove it from view.
  3. Click **Apply**. Text at the upper right corner of the **Event Log** page indicates that a filter is active. The filter is active until you clear it or until the Rack ATS restarts.
  4. A Super User or Administrator can click **Save As Default** to save this filter as the new default log view for all users.
- To remove an active filter:
  1. Click **Filter Log**.
  2. Click **Clear Filter (Show All)**.

Important points on filtering:

- Events are processed through the filter using OR logic. If you apply a filter, it works regardless of the other filters.
- Events that you cleared in the **Filter By Severity** list do not display in the filtered **Event Log**, even if selected in the **Filter by Category** list.
- Similarly, events that you clear in the **Filter by Category** list do not display in the filtered **Event Log**.

**Clear Log:** To delete all events, click **Clear Log**. Deleted events cannot be retrieved.

To disable the logging of events based on their assigned severity level or their event category, see [Configure Notifications](#), page 169.

## Reverse Lookup

### Path: Logs > Events > Reverse Lookup

With reverse lookup enabled, when a network-related event occurs, both the IP address and the domain name for the networked device with the event are logged in the Event Log. If no domain name entry exists for the device, only its IP address is logged with the event.

Since domain names generally change less frequently than IP addresses, enabling reverse lookup can improve the ability to identify addresses of networked devices that are causing events.

Reverse lookup is disabled by default. You should not need to enable it if you have no DNS server configured or have poor network performance because of heavy network traffic.

---

## Change the Log Size

**Path:** Logs > Events > Size

**Event Log Size:** Specify the maximum number of log entries (25–30000).

**NOTE:** When you resize the Event Log in order to specify a maximum size, all existing log entries are deleted. When the log subsequently reaches the maximum size, the older entries are deleted.

## Network Port Sharing Event Logs and Traps

Rack ATS events from guest units are sent to the host unit for inclusion into its log. The log entry will include the Display ID of the unit that the event occurred on. These events are then handled the same as local events from the host unit. Therefore alarms, SNMP traps, emails, Syslog, etc., will support Rack ATS events and alarms from all Rack ATS units in a group.

Example event log: Rack ATS 4: Device low load.

**NOTE:** System events will only be logged for the host Rack ATS. System events from guest Rack ATS units will not be logged on the host Rack ATS.

## View and Configure the Data Log

Use the Data Log to display measurements about the Rack ATS, the power input to the Rack ATS, and the ambient temperature of the Rack ATS.

The steps to display and resize the Data Log are the same as for the Event Log, except that you use menu options under **Data** instead of **Events**.

**NOTE:** The Data Log does not display information from NPS guest units.

## Log

**Path:** Logs > Data > Log

**View the log by date or time:** Use **Last** or **From** to define the time in which the data was logged, and click **Apply** to save your changes. (The filter configuration is saved until the unit restarts.)

**Clear Data Log:** Delete all Data Log records. Deleted Data Log records cannot be retrieved.

**Launch Log in New Window:** View the log on a separate Web page.

Click **Apply** to save your changes, or **Cancel** to discard them.

## Graphing

### Path: Logs > Data > Graphing

Data Log graphing provides a graphical display of logged data and is an enhancement of the existing Data Log feature. How the graphing enhancement displays data and how efficiently it performs will vary depending on your computer hardware, computer operating system, and the Web browser you use to access the interface of the unit.

**NOTE:** JavaScript® must be enabled in your browser to use the graphing feature. Alternatively, you can use FTP or SCP to download the Data Log and copy the information into a spreadsheet application.

**Graph Data:** Scroll through the list and select the data you would like to graph. Click **Apply** to save your changes.

**Filter the graph by date and time:** Use **Last** or **From** to define the date and time in which the events were logged. Click **Apply** to save your changes. (The filter configuration is saved until the Rack ATS restarts.)

**Launch Graph in New Window:** Open the graph on a separate Web page for a larger, more detailed view.

Click **Apply** to save your changes or **Cancel** to discard them.

## Set Logging Intervals

### Path: Logs > Data > Interval

Define, in the **Log Interval** setting, how frequently data is searched for and stored in the Data Log. When you click **Apply**, the number of possible storage days is recalculated and displays at the top of the screen. When the log is full, the oldest entries are deleted.

**NOTE:** Because the interval specifies how often the data is recorded, small intervals will cause data to be recorded more quickly and thus to hold entries for shorter periods of time.

---

## Configure Rotation Settings

### Path: Logs > Data > Rotation

Rotation causes the contents of the Data Log to be appended to the file you specify by name and location. Use this option to set up password-protection and other parameters.

- **FTP Server:** The IP address or host name of a server where the file will reside.
- **User Name, Password:** The user name and password required to send data to the repository file. This user must also be configured to have read and write access to the data repository file and the directory (folder) in which it is stored.
- **File Path:** The path to the repository file.
- **Filename:** The name of the repository file (an ASCII text file), e.g. *datalog.txt*. Any new data is appended to this file: it does not overwrite it.
- **Unique Filename:** Select this check box to save the log as *mmdyyy\_<filename>.txt*, where *filename* is what you specified in the **Filename** field above. Any new data is appended to the file but each day has its own file.
- **hours between uploads:** The number of hours between data uploads (max. 24 hours).
- **Upon failure, try uploading every *n* minutes:** The number of minutes between attempts to upload data to the file after a failed upload.
  - **Delay *n* Maximum Attempts:** The maximum number of upload attempts after an initial upload failure.
  - **Until upload succeeds:** Attempt to upload the file until the transfer is completed.

Click **Apply** to save these settings, **Cancel** to discard your changes, or **Upload Now!** to rotate log data.

## Specify Data Log Size

### Path: Logs > Data > Size

**Data Log Size:** specify the maximum number of log entries (25-1,000).

**NOTE:** When you change the maximum log size, all existing entries are deleted. When the log subsequently reaches the maximum size, the older entries are deleted.

## Firewall Log

### Path: Logs > Firewall

If you create a firewall policy, firewall events will be logged here. The information in the log can be useful to help the technical support team solve problems. Log entries contain information about the traffic and the rules action (allowed or discarded). When logged here, these events are not logged in the main Event Log.

A firewall log contains up to 50 of the most recent events. The firewall log is cleared when the management interface reboots.

For more information on firewall policies, see [Firewall Menus](#), page 153.

## Use FTP or SCP to Retrieve Log Files

An Administrator or Device User can use FTP or SCP to retrieve a tab-delimited Event Log file (*event.txt*) or Data Log file (*data.txt*) and import it into a spreadsheet.

- The file reports all recent stored events. If the log has been deleted or truncated because it reached maximum size, the deleted or truncated information will not be included in the file.
- The file includes information that the Event Log or Data Log does not display.
  - The version of the file format (first field)
  - The date and time the file was retrieved
  - The **Name**, **Contact**, and **Location** values and IP address of the Rack ATS
  - The unique **Event Code** for each recorded event (*event.txt* file only)

**NOTE:** The Rack ATS uses a four-digit year for log entries. You may need to select a four-digit date format in your spreadsheet application to display all four digits.

If you are using the encryption-based security protocols for your system, use SCP to retrieve the log file. If you are using unencrypted authentication methods for the security of your system, use FTP to retrieve the log file.

**NOTE:** By default, FTP is disabled and SCP (via SSH) is enabled.

See the *Network Management Card 3 Security Handbook*(SPD\_CCON-BDYD7K\_EN) on [www.se.com/ww/en/download](http://www.se.com/ww/en/download) for information on available security protocols and methods to set up the type of security you need. You must select a location to view and download user manuals from the website.

## Use SCP to retrieve the files

To retrieve the *event.txt* file, use the following command:

```
scp -c <cipher> username@hostname_or_ip_address:event.txt  
./event.txt
```

To use SCP to retrieve the *data.txt* file, use the following command:

```
scp -c <cipher> username@hostname_or_ip_address:data.txt ./data.  
txt
```

### NOTE:

- This SCP command is for OpenSSH. The command may differ depending on the SSH tool used.
- When using OpenSSH, *<cipher>* can be either *aes256-cbc* or *3des-cbc*.

---

## Use FTP to retrieve the event.txt or data.txt files

1. At a command prompt, type `ftp` and the IP address of the Rack ATS, and press ENTER. If the **Port** setting for the **FTP Server** option (set through the **Network** menu of the **Administration** tab) has been changed from its default (**21**), you must use the non-default value in the FTP command. For Windows FTP clients, use the following command, including spaces. (For some FTP clients, you must use a colon instead of a space between the IP address and the port number.)

```
ftp>open ip_address port_number
```

You can set a non-default port value to enhance security for the FTP Server under **Configuration > Network > Port > FTP Server**. You can specify any port from 5001 to 32768.

2. Use the case-sensitive **User Name** and **Password** for Administrator or Device User to log on. For Administrator, **apc** is the default for **User Name** and **Password**. For the Device User, the defaults are device for **User Name** and **apc** for **Password**.
3. Use the `get` command to transmit the text of a log to your local drive.  

```
ftp>get event.txt
```

or

```
ftp>get data.txt
```
4. Type `quit` at the `ftp>` prompt to exit from FTP.

## Download Log Files to a USB Flash Drive

1. Insert a USB Flash drive to the USB port on the Display Interface of the Rack ATS. Before starting the transfer, make sure the USB drive is formatted in FAT32.
2. Scroll to **Log to Flash** on the Display Screen and press the **Select** button.
3. Press the **Select** button again to export the Log files to your Flash drive.

You may abort the download by pressing the **Select** button at any time during the download process.

**NOTE:** If a `debug.txt` file or a `dump.txt` file does not exist on the Rack ATS, it cannot be downloaded to the USB Flash drive. These files are only created following an unexpected system crash or a Network Management Card (NMC) reset. The `debug.txt` and `dump.txt` files are used for technical support only.

# About Tab

## About the Rack ATS

Path: About > ATS

The screenshot shows the 'About' page for an Automatic Transfer Switch (ATS) in the Schneider Electric application. The page is titled 'Automatic Transfer Switch' and contains two main sections: 'Automatic Transfer Switch' and 'ATS Controller Firmware'.

Automatic Transfer Switch		
Name	Location	Contact
apcD8F074	Unknown	Unknown
Model Number	Rating	Serial Number
AP4452	1ø, 16 A	5A1713T59925
Hardware Revision	Manufacture Date	Phases
R01	07/17/2019	1
Circuit Breakers	Outlets	NMC Serial Number
0	10	AABBAA
NMC Uptime	Network Link	
0 Days 0 Hours 29 Minutes	Link Active	

ATS Controller Firmware		
Firmware Version	Firmware Date	Downloader Version
4.3.4	09/24/19	4.0

APC's Web Site | Testdrive Demo | EcoStruxure™ IT

© 2020, Schneider Electric. All rights reserved. Site Map | Updated: 09/17/2020 at 10:07 (apc08f074.us.ddns.schneider-electric.com)

The hardware information is useful to APC Customer Support for troubleshooting problems with the Rack ATS. The serial number and MAC address are also available on the Rack ATS itself.

**Management Uptime** is the length of time the network management interface has been running continuously.

## About the Network

Path: About > Network

Information for the Application Module, APC OS (AOS), and APC Boot Monitor indicates the name, the firmware version, and the date and time each firmware module was created. This information is also useful in troubleshooting and enables you to determine if updated firmware is available at the website, [www.se.com](http://www.se.com).

---

## Support Resources

### Path: About > Support

This page provides links to multiple support resources:

- **Knowledge Base:** Direct link to FAQs on the Schneider Electric website.
- **Company Contact Information:** Provides phone numbers for multiple support services provided by Schneider Electric.
- **Software & Firmware Downloads:** Download software upgrades for your product.

**Technical Support Debug Information Download:** With this option, you can consolidate various data in this interface into a single zipped file for troubleshooting purposes and customer support. The data includes the Event and Data logs, the configuration file and complex debugging information. Click **Generate Logs** to create the file, and **Download** to download them. You will be asked whether you want to view or save the zipped file.

# How to Export Configuration Settings

## Summary of the Procedure

A Super User/Administrator can retrieve the .ini file of a Rack ATS and export it to another Rack ATS or to multiple Rack ATS units. The steps are below; see details in the sections following.

1. Configure a Rack ATS with the desired settings, and retrieve the .ini file from that Rack ATS.
2. If desired, you can edit the .ini file with any text editor before uploading it to another device. Data entries may not be moved between sections. Lines will not be processed if they start with a semicolon (;).
3. Use a file transfer protocol supported by the Rack ATS to transfer a copy to one or more other devices. For a transfer to multiple Rack ATS units, use an FTP or SCP script or the .ini file utility. Each receiving unit uses the file to re-configure its own settings and then deletes it.

**NOTE:** FTP is disabled by default. If needed, you can enable FTP under **Configuration > Network > FTP Server**.

**NOTE:** Managing Users via the config.ini - Users are no longer managed via the config.ini in any form. Users are now managed via a separate file with the .csf extension. For further information on this topic, refer to FAQ article FA156117: How can I mass configure a Network Management Card (NMC) or NMC embedded product? To find an FAQ article, go to [www.se.com](http://www.se.com), and select your location. Then select **Support > Documentation & Software Downloads** and enter the article number or title of the FAQ in the Search bar.

## Contents of the .ini File

The config.ini file you retrieve from an Rack ATS contains the following:

- Section headings and keywords (only those supported for the particular device from which you retrieve the file): **Section headings** are category names enclosed in brackets ([ ]). **Keywords**, under each section heading, are labels describing specific Rack ATS settings. Each keyword is followed by an equal sign and a value (either the default or a configured value).
- The **Override** keyword: With its default value, this keyword helps prevent the exporting of one or more keywords and their device-specific values. For example, in the [NetworkTCP/IP] section, the default value for **Override** (the MAC address of the Rack ATS) blocks the exporting of values for the `SystemIP`, `SubnetMask`, `DefaultGateway`, and `BootMode`.

## .ini and Network Port Sharing

The .ini configuration utility is able to get and set values for all devices in a group. In order to be backwards compatible, the host Rack ATS will always be designated as first, "ATS\_A". Any guest Rack ATS units are then designated "ATS\_B", "ATS\_C", and "ATS\_D" based on their Display ID in ascending order up to ATS\_Z. After that, further PDUs are designated ATS\_AA, up to ATS\_FF. Therefore, "ATS\_A" will not necessarily correlate to Display ID 1, and so on.

**NOTE:** Because of the large number of configuration values possible in a Rack ATS group, it may take a very long time to process an INI file set. For example, a Rack ATS group of 4 units with all values changing may take 30 minutes to complete processing.

## Detailed Procedures

### Retrieve .ini File

If possible, use the interface of a Rack ATS to configure it with the settings to export. (Directly editing the .ini file risks introducing errors).

Then retrieve *config.ini* from the configured Rack ATS via FTP, SCP, or the Web UI:

#### To use FTP

1. Open a connection to the Rack ATS using its IP address:

```
ftp> open ip_address
```

2. Log on using the Super User/Administrator user name and password.

3. Retrieve the *config.ini* file containing the settings of the Rack ATS:

```
ftp> get config.ini
```

The file is written to the folder from which you launched FTP.

To export configuration settings to multiple Rack ATS units, see FAQ article FA156117: *How can I mass configure a Network Management Card (NMC) or NMC embedded product?* To find an FAQ article on [www.se.com](http://www.se.com), enter the title or number of the article in the search bar. On the resulting page, select **Faq** to narrow your search results to only FAQ articles.

#### To use SCP

Use the following command:

```
scp -c <cipher> username@hostname_or_ip_address:config.ini  
./config.ini
```

Then enter the correct password.

#### NOTE:

- This SCP command is for OpenSSH. The command may differ depending on the SSH tool used.
- When using OpenSSH, <cipher> can be either aes256-cbc or 3des-cbc. Aes256 is more secure.

#### To use the Web UI:

Navigate to **Configuration > General > User Config File** and select **Download**.

## Edit .ini File

Edit the file carefully before you transfer it to other Rack ATS units.

1. Use a text editor to make your changes.
  - Section headings, keywords, and pre-defined values are not case-sensitive, but string values that you define are case-sensitive.
  - Use adjacent quotation marks to indicate no value. For example, `LinkURL1=""` indicates that the URL is intentionally undefined.
  - Enclose in quotation marks any values that contain leading or trailing spaces or are already enclosed in quotation marks.
  - To export scheduled events, configure the values directly in the .ini file.
  - To export a system time with the greatest accuracy, if the receiving Rack ATS units can access a Network Time Protocol server, configure `enabled` for `NTPEnable`:  

```
NTPEnable=enabled
```

Alternatively, reduce transmission time by exporting the `[SystemDate/Time]` section as a separate .ini file.
  - To add comments, start each comment line with a semicolon (;).
2. Copy the customized file to another file name in the same folder:
  - The file name can have up to 64 characters and must have the .ini suffix.
  - Retain the original customized file for future use. **The file that you retain is the only record of your comments.**

## Transfer the File To a Single Rack ATS

To transfer the .ini file to another Rack ATS, do either of the following:

- From the Web UI of the receiving Rack ATS, select **Configuration > General > User Config File**. Enter the full path of the file, or use Browse on your local PC.
- Use any file transfer protocol supported by Rack ATS units, i.e., FTP, FTP Client, SCP, or TFTP. The following example uses FTP:
  1. From the folder containing the copy of the customized .ini file, use FTP to log in to the Rack ATS to which you are exporting the .ini file:

```
ftp> open ip_address
```
  2. Export the copy of the customized .ini file to the root directory of the receiving Rack ATS:

```
ftp> put filename.ini
```

## Transfer the File To Multiple Rack ATS Units

To transfer the .ini file to multiple Rack ATS units, do one of the following:

- Use FTP or SCP, but write a script that incorporates and repeats the steps used for exporting the file to a single Rack ATS.
- Use a batch processing file and the .ini file utility.

To create the batch file and use the utility, see FAQ article FA156117: *How can I mass configure a Network Management Card (NMC) or NMC embedded product?* To find an FAQ article on [www.se.com](http://www.se.com), enter the title or number of the article in the search bar. On the resulting page, select **Faq** to narrow your search results to only FAQ articles.

# The Upload Event and Error Messages

## The Event and Its Error Messages

The following event occurs when the receiving Rack ATS completes using the .ini file to update its settings.

Configuration file upload complete, with number valid values

If a keyword, section name, or value is invalid, the upload by the receiving Rack ATS succeeds, and additional event text states the error.

Event text	Description
Configuration file warning: Invalid keyword on line number. Configuration file warning: Invalid value on line number.	A line with an invalid keyword or value is ignored.
Configuration file warning: Invalid section on line number.	If a section name is invalid, all keyword/value pairs in that section are ignored.
Configuration file warning: Keyword found outside of a section on line number.	A keyword entered at the beginning of the file (i.e., before any section headings) is ignored.
Configuration file warning: Configuration file exceeds maximum size.	If the file is too large, an incomplete upload occurs. Reduce the size of the file, or divide it into two files, and try uploading again.

## Messages in Config.ini

A Rack ATS from which you download the config.ini file must be discovered successfully in order for its configuration to be included. If the Rack ATS is not present or is not discovered, the config.ini file contains a message under the appropriate section name, instead of keywords and values. For example: Rack ATS not discovered

If you did not intend to export the Rack ATS configuration as part of the .ini file import, ignore these messages.

## Errors Generated By Overridden Values

The `Override` keyword and its value will generate error messages in the Event Log when it blocks the exporting of values. See [Contents of the .ini File, page 189](#) for information about which values are overridden.

Because the overridden values are device-specific and not appropriate to export to other Rack ATS units, ignore these error messages. To prevent these error messages, delete the lines that contain the `Override` keyword and the lines that contain the values that they override. Do not delete or change the line containing the section heading.

## Related Topics

On Windows operating systems, instead of transferring .ini files, you can use the Device IP Configuration Wizard to update the basic TCP/IP settings of the Rack ATS and configure other settings through its user interface. See [Device IP Configuration Utility, page 20](#) for instructions to download and install the Device IP Configuration Wizard.

# Troubleshooting

## Access Problems

For problems that persist or are not described here, contact the Customer Care at [www.se.com](http://www.se.com).

Problem	Solution
After a Network Port Sharing host is updated to new firmware, the guest Rack ATS units show a "firmware version does not match" alarm.	This will be automatically resolved by the host unit, given time. Events are logged in this order : "Remote RATS 2 (SN: xxxxxxxxxxxx) firmware version does not match." > "Guest RATS firmware download started." > "Guest RATS firmware download completed." > "Remote RATS 2 (SN: xxxxxxxxxxxx) firmware version alarm has been cleared." > "Remote RATS 2 (SN: xxxxxxxxxxxx) communication established."
Unable to ping the Rack ATS	If the Rack ATS unit's Status LED is green, try to ping another node on the same network segment as the Rack ATS. If that fails, it is not a problem with the Rack ATS. If the Status LED is not green, or if the ping test succeeds, perform the following checks: <ul style="list-style-type: none"> <li>• Verify all network connections.</li> <li>• Verify the IP addresses of the Rack ATS and the NMS.</li> <li>• If the NMS is on a different physical network (or subnetwork) from the Rack ATS, verify the IP address of the default gateway (or router).</li> <li>• Verify the number of subnet bits for the Rack ATS's subnet mask.</li> </ul>
Cannot allocate the communications port through a terminal program	Before you can use a terminal program to configure the Rack ATS, you must shut down any application, service, or program using the communications port.
Cannot access the CLI through a serial connection	Make sure that you did not change the baud rate. Try 2400, 9600, 19200, or 38400.
Cannot access the CLI remotely	<ul style="list-style-type: none"> <li>• Make sure you are using the correct access method, Telnet or Secure SHell (SSH). The Super User or an Administrator can enable these access methods. By default, Telnet is disabled, and SSH is enabled. SSH and Telnet can be enabled/disabled independently.</li> <li>• For SSH, the Rack ATS may be creating a host key. The Rack ATS can take up to one minute to create the host key, and SSH is inaccessible for that time.</li> </ul>
Cannot access the Web UI	<ul style="list-style-type: none"> <li>• Verify that HTTP or HTTPS access is enabled.</li> <li>• Make sure you are specifying the correct URL — one that is consistent with the security system used by the Rack ATS. This requires <b>https</b>, not <b>http</b>, at the beginning of the URL.</li> <li>• Verify that you can ping the Rack ATS.</li> <li>• Verify that you are using a Web browser supported for the Rack ATS. See <i>Web User Interface</i>, page 124.</li> <li>• If the Rack ATS has just restarted and SSL/TLS security is being set up, the Rack ATS may be generating a server certificate. The Rack ATS can take up to one minute to create this certificate, and the SSL/TLS server is not available during that time.</li> </ul>
Cannot communicate using Network Port Sharing (NPS)	<ul style="list-style-type: none"> <li>• If you are having communications problems with Network Port Sharing, check that the total length of network cable between up to 32 units is not more than 10 meters.</li> <li>• If you are using Network Port Sharing and do not see one or more of the units in the group, check that all units in the group are using the same firmware revision. Guest Rack ATS units should receive firmware updates from their hosts, but manually updating units that seem to be completely unresponsive to the host's firmware revision may resolve the issue. You can download appropriate firmware revisions from the Schneider Electric website, <a href="http://www.se.com">www.se.com</a>.</li> </ul>

## SNMP Problems

Problem	Solution
Unable to perform a GET	<ul style="list-style-type: none"> <li>Verify the read (GET) community name (SNMPv1) or the user profile configuration (SNMPv3).</li> <li>Use the CLI or Web UI to confirm that the NMS has access. See <i>SNMP Options</i>, page 163.</li> </ul>
Unable to perform a SET	<ul style="list-style-type: none"> <li>Verify that SNMP is enabled. SNMPv1 and SNMPv3 are disabled by default.</li> <li>Verify the read/write (SET) community name (SNMPv1) or the user profile configuration (SNMPv3).</li> <li>Use the CLI or Web UI to confirm that the NMS has write (SET) access (SNMPv1) or is granted access to the target IP address through the access control list (SNMPv3). See <i>SNMP Options</i>, page 163.</li> </ul>
Unable to receive traps at the NMS	<ul style="list-style-type: none"> <li>Make sure the trap type (SNMPv1 or SNMPv3) is correctly configured for the NMS as a trap receiver.</li> <li>For SNMP v1, query the <b>mconfigTrapReceiverTable</b> MIB OID to verify that the NMS IP address is listed correctly and that the community name defined for the NMS matches the community name in the table. If either is not correct, use SETs to the <b>mconfigTrapReceiverTable</b> OIDs, or use the CLI or Web UI to correct the trap receiver definition.</li> <li>For SNMPv3, check the user profile configuration for the NMS, and run a trap test. See <i>SNMP Options</i>, page 163, <i>Configure Notifications</i>, page 169, and <i>SNMP Traps</i>, page 173 for more information on profiles and trap tests.</li> </ul>
Traps received at an NMS are not identified	See your NMS documentation to verify that the traps are properly integrated in the alarm/ trap database.

# Worldwide Customer Support

Support for this product is available at [www.se.com](http://www.se.com).

---

## Source Code Copyright Notice

cryptlib copyright Digital Data Security New Zealand Ltd 1998.

Copyright © 1990, 1993, 1994 The Regents of the University of California. All rights reserved.

This code is derived from software contributed to Berkeley by Mike Olson.

Redistribution and use in source and binary forms, with or without modification, are permitted provided that the following conditions are met:

1. Redistributions of source code must retain the above copyright notice, this list of conditions and the following disclaimer.
2. Redistributions in binary form must reproduce the above copyright notice, this list of conditions and the following disclaimer in the documentation and/or other materials provided with the distribution.
3. Redistributions in binary form must reproduce the above copyright notice, this list of conditions and the following disclaimer in the documentation and/or other materials provided with the distribution.
4. Neither the name of the University nor the names of its contributors may be used to endorse or promote products derived from this software without specific prior written permission.

THIS SOFTWARE IS PROVIDED BY THE REGENTS AND CONTRIBUTORS "AS IS" AND ANY EXPRESS OR IMPLIED WARRANTIES, INCLUDING, BUT NOT LIMITED TO, THE IMPLIED WARRANTIES OF MERCHANTABILITY AND FITNESS FOR A PARTICULAR PURPOSE ARE DISCLAIMED. IN NO EVENT SHALL THE REGENTS OR CONTRIBUTORS BE LIABLE FOR ANY DIRECT, INDIRECT, INCIDENTAL, SPECIAL, EXEMPLARY, OR CONSEQUENTIAL DAMAGES (INCLUDING, BUT NOT LIMITED TO, PROCUREMENT OF SUBSTITUTE GOODS OR SERVICES; LOSS OF USE, DATA, OR PROFITS; OR BUSINESS INTERRUPTION) HOWEVER CAUSED AND ON ANY THEORY OF LIABILITY, WHETHER IN CONTRACT, STRICT LIABILITY, OR TORT (INCLUDING NEGLIGENCE OR OTHERWISE) ARISING IN ANY WAY OUT OF THE USE OF THIS SOFTWARE, EVEN IF ADVISED OF THE POSSIBILITY OF SUCH DAMAGE.



Schneider Electric  
35 rue Joseph Monier  
92500 Rueil Malmaison  
France

+33 (0) 1 41 29 70 00

[www.se.com](http://www.se.com)

As standards, specifications, and design change from time to time, please ask for confirmation of the information given in this publication.

© 2025 Schneider Electric. All rights reserved.

990-91718C-001